

TYLÖ

REDEFINING WELLNESS



SAUNA
STEAM
INFRARED

tylo.com

A NEW DEFINITION OF WELLNESS

Over 75 years of shaping modern wellness

In today's interconnected world, finding harmony between body and mind, work and home, and the physical and digital has never been more essential. Our sauna, steam, and infrared solutions blend effortlessly into your everyday life, creating space for genuine wellness to take root and thrive naturally.

CONTENTS

About Tylo	4
SAUNA	
Sauna benefits	7
Sauna solutions	8
MODULAR SAUNA ROOM	10
Reflection sauna room	12
Harmony sauna room	16
CUSTOMISED SAUNA SOLUTIONS	26
Create your dream sauna	28
SAUNA HEATERS	
Crown heater	50
Traditional sauna heaters	58
Combi sauna heaters	60
CONTROL PANELS	62
ACCESSORIES	64
STEAM	
Steam shower	68
Steam column	70
Steam rooms	72
CUSTOMISED STEAM ROOMS	74
ACCESSORIES	80
INFRARED	
Infrared sauna rooms	84
Panels for infrared saunas	90
COMMERCIAL	
Sauna heaters	94
Energy consumption	99
Steam generators	102
Control panels	102
Panacea Twin	104
REFERENCES	106
TABLES	114
TECHNICAL INFORMATION AND DRAWINGS	120

We reserve the right to make changes to our range.
For the latest version visit tylo.com/downloads

About Tylö

A NEW DEFINITION OF WELLNESS

With a huge passion for sauna and wellness, solid traditions in craftsmanship and profound knowledge, Tylö is redefining the sauna scene by always continuing to create top-quality sauna products made to be a vital part of healthy living. When you are investing in a Tylö product, you are not only investing in a product, you are also investing in your health.

HIGH QUALITY

When you choose a Tylö product, you can rest assured that it has been crafted with the utmost care and attention to detail. Our commitment to quality is evident in every aspect of our manufacturing process. We are proud to be able to provide an excellent product and strongly believe in attention to detail, from selection of raw materials to final inspection.

EFFICIENT HEATING

Our heaters feature IntelliAir, a system that uses integrated air chambers to distribute air and heat evenly throughout the sauna. The result is faster, more consistent heating. Our sauna rooms

are well insulated, allowing them to retain heat longer and reduce energy use over time. Our solutions are carefully designed for comfort, reliable operation and long-lasting performance.

DEVELOPMENT

Years of development, experience and a relentless strive for perfection have led us to where we are today. Masters of providing relaxation year after year, for you and your health.

INNOVATIVE DESIGN

Tylö combines modern technology with innovative design to create unique sauna experiences. Choose between our pre-fabricated solutions or your own customised design. Tylö is your complete partner with endless design options.

CRAFTED IN SWEDEN

We take pride in our extraordinary craftsmanship and precision-made products, manufactured at our Swedish factory. All our heaters and sauna rooms are crafted with care right here in Sweden.





SAUNA

9 Benefits of sauna

1. MUSCLE RECOVERY

An aid to muscle recovery after physical exertion through enhanced relaxation and healthy circulation.

2. CLEANSSES THE SKIN

Stimulates deep sweating to help cleanse the skin, leaving a feeling of freshness.

3. RELAXATION

Gives a warm, calming environment that enhances relaxation and inner balance.

4. WELLBEING

Regular sauna use can help improve vitality and a balanced feeling of wellbeing.

5. CIRCULATION

Can enhance healthy blood circulation and contribute to cardiovascular health.

6. GOOD SLEEP

Enhances relaxation and can help you wind down before a good night's sleep.

7. STRESS REDUCTION

Regular saunas can help reduce stress by enhancing relaxation and lowering levels of cortisol, the body's principal stress hormone.

8. SOCIAL BENEFITS

Create a relaxing environment for socialising with family and friends.

9. LAST BUT NOT LEAST: IT JUST FEELS GOOD

A sauna not only feels good, it's good for you.

Two ways to build your sauna



1. Modular sauna solutions

The perfect choice if you have an open space to place a sauna room in.

FLEXIBLE SOLUTIONS

Tylö modular sauna rooms are carefully designed to fit into any modern home. The room is prefabricated and comes complete with smart solutions to make it easy and quick to assemble. A flexible solution designed to fit into a variety of spaces!

CUSTOM CHOICES

Craftsmanship, the best materials, and attention to detail are key to this modern sauna solution. With a variety of sizes, materials and finishes, our

modular sauna rooms can be customised to fit your specific needs and preferences!

SIMPLE ASSEMBLY

Enjoy fast and easy assembly with this convenient sauna solution. The prefabricated modules fit easily together and require no additional framing or insulation. A sauna solution made to fit into modern life!

Read more on pages 10-25



2. Customised sauna solutions

If you have a room available for a sauna

UNIQUE DESIGN

Customised solutions designed to fit your space and preferences. Create your own sauna experience by choosing panels, interior and lighting. Whether you choose from our standard range or a fully customised solution, Tylö is the only partner you need.

TAILORED TO YOUR SPACE

Designed to fit the exact shape of your room and make the most of the available space. With innovative use of glass and doors, unusual angles and unique bench configurations, even more complex spaces can be utilised.

Read more on pages 26-47



Modular sauna room



Reflection

Introducing Reflection, the new sauna room that gets its name from its stunning smoked glass front that beautifully reflects on the outside. Once you step inside, you'll be greeted by a central portal that leads you to the heart of the room where you can relax and reflect.

- The Reflection room is fully equipped
- Elite control panel built-in
- Beautiful designed Valchromat material on the outside
- Integrated high-quality Bluetooth® stereo speakers

Read more at tylo.com/reflection

The portal's significance lies in its seamless concealment of electronics and lighting within Reflection's design. This perfect blend wraps you in the peace of your surroundings, offering complete immersion. Adjust the lighting to your liking, change the music, and fully embrace this modern twist on a traditional sauna for a truly comprehensive experience.



PORTAL

The portal features LED lighting on the sides, three spotlights, a built-in Elite control panel, and integrated high-quality Bluetooth® stereo speakers.



RIBBED PANELS

Available in alder and thermo alder.



WIDE PANELS

Available in aspen and thermo aspen.



OPTIONAL FLOOR

You can choose to add flooring to your room. Available in aspen, thermo aspen, alder and thermo alder.

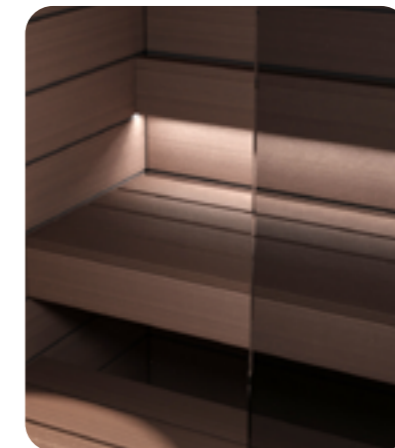

WIDE INTERIOR

Available in aspen and thermo aspen.



RIBBED INTERIOR

Available in alder and thermo alder.

REFLECTION

Glass corner or glass front

Choose between a glass front or glass corner for your Reflection sauna room and create a unique space of your own.

RIBBED OR WIDE?

Opt for our modern Ribbed panels and interior in alder or thermo alder, or the soft and smooth Wide panels and interior in aspen or thermo aspen.



Glass corner with Ribbed thermo alder interior and panels



Glass front with Ribbed alder interior and panels



Glass corner with Wide thermo aspen interior and panels



Glass front with Wide aspen interior and panels

Harmony

Tylö's modular Harmony sauna room is the solution for those who want a quick and easy route to sauna enjoyment. Your sauna is delivered as prefabricated components that are easy to assemble. It is all set up for installation of electrical systems and the ventilation systems are ready to go. The end result is an attractive and seamlessly constructed sauna where all nails, screws and joints are covered.



Harmony with Glass Corner (lighting is optional)

Create your Harmony in 7 steps

In just a few easy steps, personalise and modify to fit seamlessly into your home.



1. LAYOUT

Choose between square, corner, glass front and glass corner.

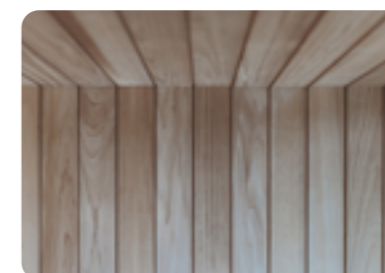

2. PANEL

Horizontal or vertical panelling available in different types of wood: spruce, alder, aspen and thermo-treated aspen.



3. INTERIOR

Choose between Classic, Slim and Wide benches made of alder, aspen or thermo-treated alder. Select a closed style with skirting panel or an open style without skirting panel.

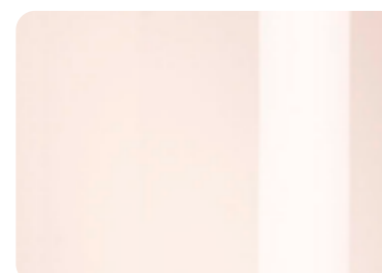

4. GLASS

You can choose between clear, tinted or frosted glass.



5. DOOR HANDLE

Choose between horizontal and vertical orientation or go for the design handle.



6. LIGHTING

Soffits come with built-in lighting.



7. HEATER

Here it is important to know the size of the sauna. Use the table on page 114 to find the recommended heater for your sauna.

Use our 3D configurator* to create your dream sauna online
3dconfigurator.tylo.com/portal/configurator
 *Available on desktop only.

HARMONY

1. Layout

You might think a Harmony room is just a fixed module. But it is really adaptable and fits almost any space thanks to all the variations and sizes.



DAY 1 Delivery & construction

Prefabricated components delivered as a flat-pack kit.



DAY 2 Ready to take a Sauna!



CORNER
Aspen



CORNER WITH GLAZED SECTION
Spruce



SQUARE
Heat-treated aspen



SQUARE WITH GLAZED SECTION, FRONT
Heat-treated Aspen



SQUARE WITH GLAZED SECTION, SIDES Aspen



SQUARE WITH GLAZED SECTION, FRONT AND SIDES Spruce



GLASS FRONT
Heat-treated Aspen



GLASS CORNER
Aspen

The standard height is 2073 mm but can be customised, and the minimum size is 1159 x 1159 mm. You can make it as large as you want, including for professional use in spas and leisure centres. Go to tylo.com for drawings and more information on Harmony.

BUILD YOUR DREAM SAUNA

Use our 3D configurator* to create your dream sauna online
3dconfigurator.tylo.com/portal/configurator

*Available on desktop only.

HARMONY

2. Panels

Discover our high-quality sauna panels in various designs that perfectly match your Harmony's interior design. Choose between vertical or horizontal lines for a customisable and elegant sauna experience. All panels in Harmony come with an STS profile.



Thin Aspen, vertical.

**ASPEN**

Aspen is a light, relatively soft and brittle wood that retains its shape despite changes in air humidity. It has low thermal conductivity and does not release resin and is therefore commonly used for saunas.

Size: 12 x 95 mm

**THERMO ASPEN**

Thermo aspen has a much darker shade than nontreated. Thermo aspen is highly stable because it contains and absorbs less moisture than when nontreated.

Size: 12 x 95 mm

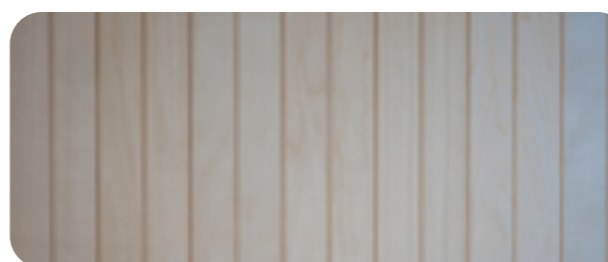
**THIN ASPEN**

Give your sauna a trendy look with these thin aspen panels. Made from the highest quality wood to give your sauna a modern Scandinavian touch.

Size: 12 x 95 mm

**THIN THERMO ASPEN**

Give your sauna a trendy look with these thin, thermo-treated aspen panels. Made from the highest quality wood to give your sauna a modern Scandinavian touch.

Size: 12 x 95 mm

**BRUSHED THERMO ASPEN**

Brushed thermo-treated Aspen panels offer a luxurious and rustic character. The distinctive brushed surface provides an authentic texture that brings a unique expression to your sauna. Size: 12 x 95 mm

**DRIFTWOOD**

Give your sauna a rustic feel with our Driftwood panels. Wood is, and will always be, a natural product. Therefore, variations and differences between the boards can occur. Size: 2500 x 1250 x 16 mm

**SPRUCE**

Spruce is one of the most common trees in the Nordic countries. It's light in colour and is a medium soft type of wood. Size: 12 x 95 mm

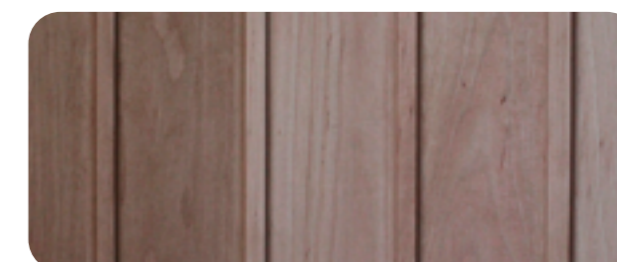
**ALDER**

Alder panels have a warm tone and even texture that give the sauna a natural look with a sense of both timelessness and modernity. The wood is medium-density, free from resin and highly resistant to moisture. Size: 12 x 95 mm

HARMONY

3. Interior

Harmony interiors are available in a number of different designs and are made to match the style of your Harmony. Your sauna room can be designed to custom standards by choosing from several types of wood and designs.



CLASSIC

The Classic range of solid aspen, alder or heat-treated alder sauna interior is available in pre-cut measurements or may be cut to individual preferences. The range includes benches and back rests with skirting and side panels (see page 31) for a finished look.



SLIM

Classic Slim sauna interiors in aspen, alder or heat-treated alder are available in pre-cut measurements but may be cut to individual requirements for custom builds. The range includes benches and back rests with skirting and side panels for a finished look.

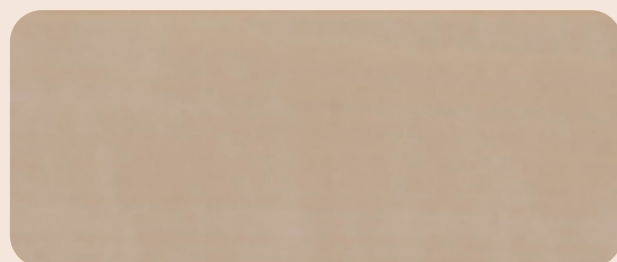

ASPEN

A light and relatively soft wood and the most popular for sauna interiors.

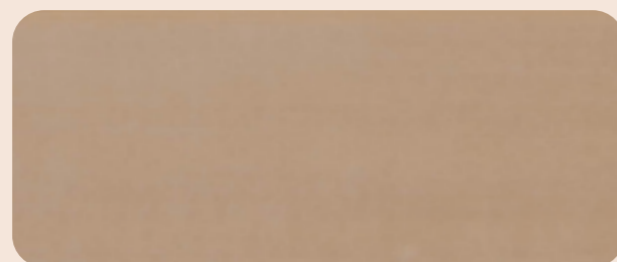

THERMO ASPEN

Thermo-treated alder is dark and a good match to thermo-treated aspen on the walls.



ALDER

A soft, reddish wood that does not secrete resin. Can change in colour over the course of time.

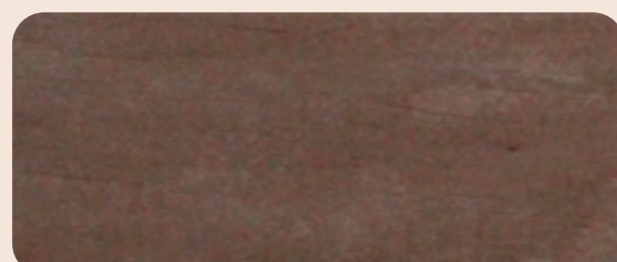

THERMO ALDER

Thermo-treated alder is dark and a good match for thermo-treated aspen on the walls.



WIDE

The classic Wide range of aspen, alder or thermo-treated alder. Sauna interiors available in custom measurements as flex interior. The range includes benches and back rests.

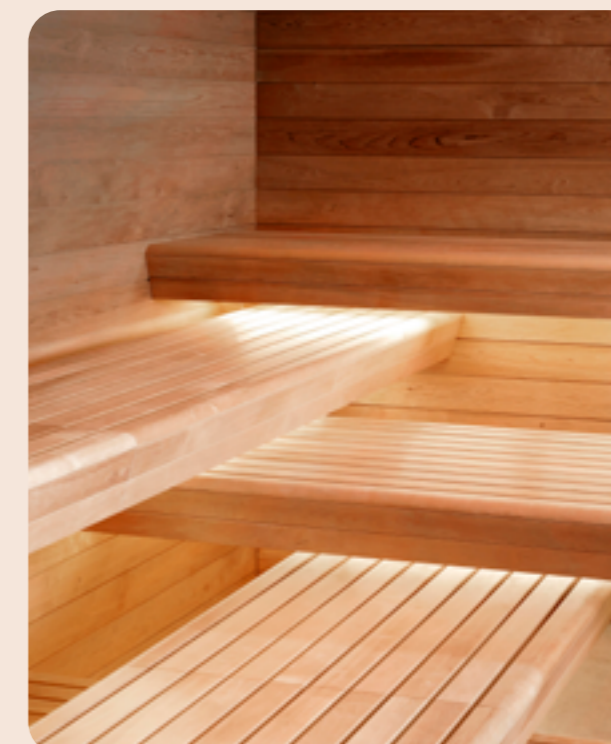

PANORAMA

The Panorama range of sauna benches with overlapping design are made of aspen, alder and thermo-treated alder and are available in custom measurements as flex interior. Also with wide bench boards as an option.

HARMONY

4. Glass

Whether it's a glass door, glass section or glass front, our glass products are engineered to endure significant temperature variations between sauna interior and exterior, maintaining their shape and integrity.

Opt for clear glass for an open ambience, bronze glass for added warmth, or frosted glass to create a private, relaxing retreat.

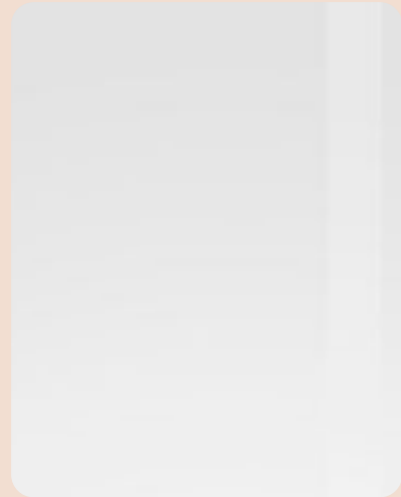

CLEAR GLASS

8 mm tempered safety glass.



BRONZE GLASS

8 mm tempered safety glass.

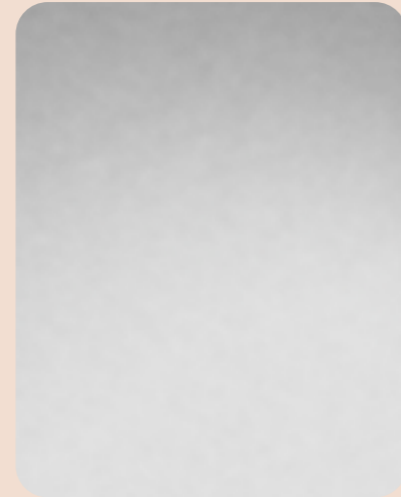

FROSTED GLASS

8 mm tempered safety glass.

HARMONY

5. Dörrhandtag

Choose between horizontal and vertical orientation or go for the design handle.



HORIZONTAL



VERTICAL



DESIGN HANDLE



**HORIZONTAL
ALU LINE**



PANACEA

HARMONY

6. Lighting

Tylö offers an extensive range of sauna lighting for the Harmony model. Hidden lighting behind benches and backrests creates a comfortable atmosphere, while lights mounted on the wall or in the ceiling offer a more distinctive look. See all lighting solutions on pages 42-47.

For exterior lighting, opt for a soffit seamlessly integrated into the exterior design.



WITH SOFFIT



WITHOUT SOFFIT

HARMONY

7. Sauna heaters

Find the heater for your sauna on pages 48-61.



SAUNAS

Customised sauna solutions



Create your dream sauna in 7 steps

Do you have a space waiting to be transformed into a sauna? Regardless of whether you have a small walk-in wardrobe space or a large room, you can design exactly what you want, panel by panel. Enhance the look with fresh Taika designs on the walls and new benches. Choose from standard options or contact a dealer for a personalised sauna just for you.

Build your dream sauna step by step:

1. SAUNA PANELS

Choose from a wide range of options: from modern Taika panels, classic spruce, or heat-treated aspen or alder panels to more unique designs such as brushed or driftwood panels. Install them horizontally or vertically to achieve your desired look. Ensure proper insulation with at least 45 mm thick mineral wool. Leave an air gap between the outer wall and sauna insulation if against a cold outer wall. Remember to build your sauna as a separate 'room-in-room' structure.

2. WOODEN INTERIOR

Match the wall panels or create a beautiful contrast with benches and backrests. Opt for slim or wide boards in a classic or creative floating bench design.

3. EXTRAS

Add comfort and style with skirting, floor grating, armrests, or side panels.

4. GLASS FRONTS AND CORNERS

Enhance the luxury factor with glass fronts and corners. Choose our durable, prefabricated glazed sections made of safety glass.

5. DOORS

Ensure outward-opening sauna doors sealed with a magnetic lock, self-closing hinges, or equivalent for easy access. We recommend using professionally made sauna doors.

6. HEATERS

Select the appropriate sauna heater based on the volume of the sauna room. As a rule of thumb, use approximately 1 kW per 1.3 m³ of room volume. For saunas with large glass surfaces or heavy wall materials, adjust output accordingly.

7. LIGHTS

Customise sauna lighting to your preference. Conceal lights under benches and backrests for a cozy ambiance or choose retro-style lamps for wall or ceiling placement.

Important to get right

VENTILATION

The most functional ventilation is the traditional way using a vent that can be opened manually for supply air through the wall under the heater, and an exhaust air vent on the wall diagonally across the room. Supply air should always be taken from and exhaust air vented to the same room.

Air circulation from the door must always work in harmony with hot air from the heater. The heater is therefore always placed on the same wall as the door. The supply air vent is placed directly through the wall aligned with the centre of the heater.

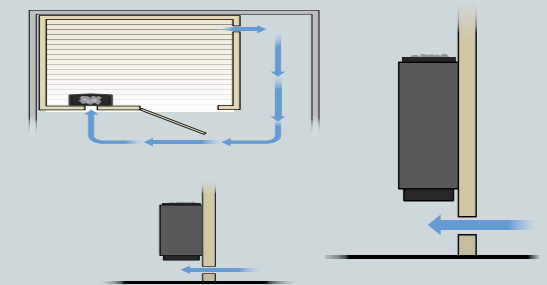

1. Sauna panels

Tylö's beautiful sauna panels can be placed either horizontal or vertically to create the look you want. For any other kind of wood, contact your dealer for special designs.

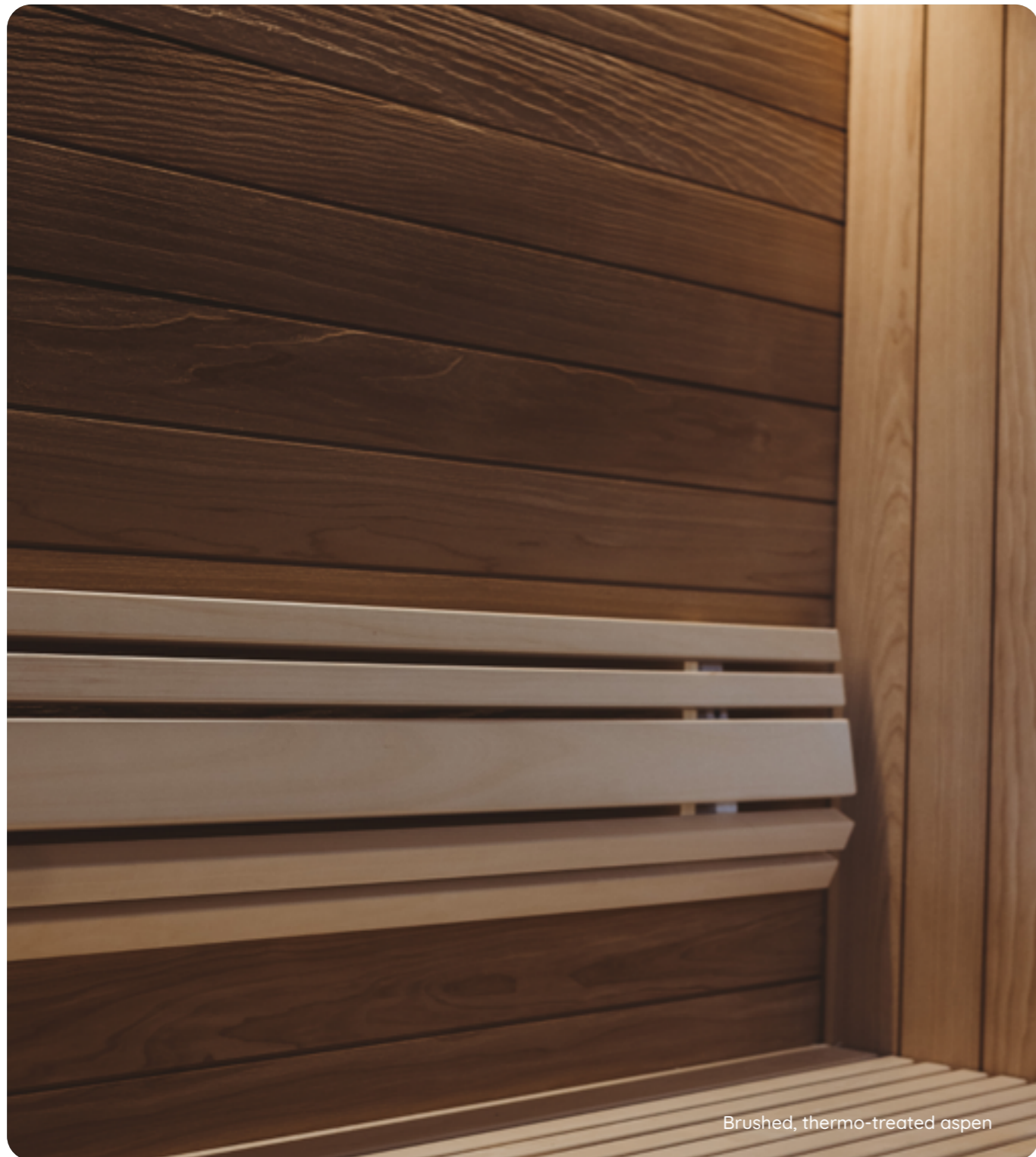

Brushed, thermo-treated aspen



ASPEN
Beautiful light aspen panels create a clean and minimalistic look. Available in STS and STP profiles. Sizes: 15 x 90 mm and 15 x 120 mm



THERMO ASPEN
Thermo-treated aspen creates a warm brown panel, for an elegant and luxurious feeling. STS-profile. Sizes: 15 x 90 mm and 15 x 120 mm



THIN ASPEN
High quality ribbed aspen panels give a sauna room a modern Scandinavian touch. STS-profile. Size: 12 x 95 mm



THIN THERMO ASPEN
Thin thermo-treated aspen panels give the room a trendy, designer look. STS-profile. Size: 12 x 95 mm



BRUSHED THERMO ASPEN
The unique, brushed surface gives an authentic look that will make your sauna stand out from others. STS-profile. Size: 12 x 95 mm



DRIFTWOOD
Give your sauna a rustic and natural feel with our Driftwood panels in natural grey. Size: 2500 x 1250 x 16 mm



SPRUCE
Spruce panels for a traditional and Scandinavian feeling in your sauna. STS-profile. Size: 12 x 95 mm



THERMO ASPEN DARK
Thermo aspen in a darker tone gives the sauna a warm and exclusive expression. STS profile. Size: 15 x 90 mm

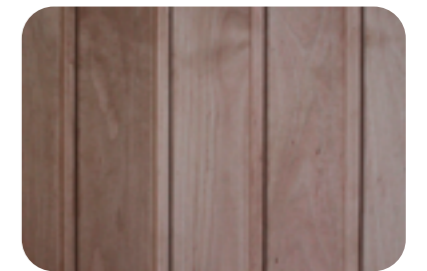

ALDER
Alder panels give your room a trendy, yet warm and cosy designer feel. Available in two profiles, STS 12 x 95 mm and STP 15 x 95 mm

Difference between STP and STS profiles



STP ASPEN
STP profile panels have rounded edges that create a soft look.

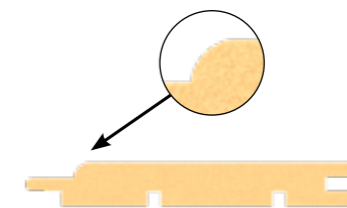

1. SAUNA PANEL STP PROFILE



STS ASPEN
STS profile panels have square corners to give a modern look.

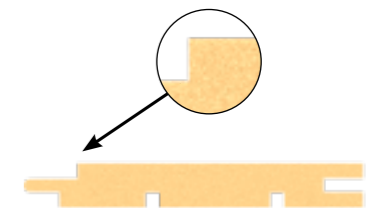

2. SAUNA PANEL STS PROFILE

Taika panels

Give your sauna a modern look and feel with Taika panels. The perfect solution if you are looking for a contrast in your sauna. The panels are wider than standard and can be placed horizontal or vertically.



BLACK



GREY

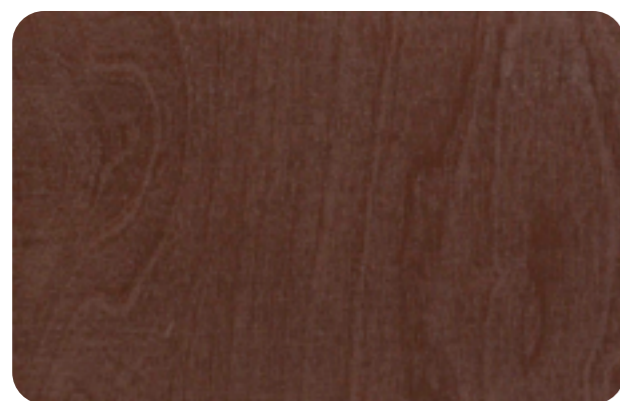

BROWN



UNTREATED



WHITE

ELEVATE YOUR SAUNA EXPERIENCE

Taika panels allow you to effortlessly create an inviting and striking style for your sauna.

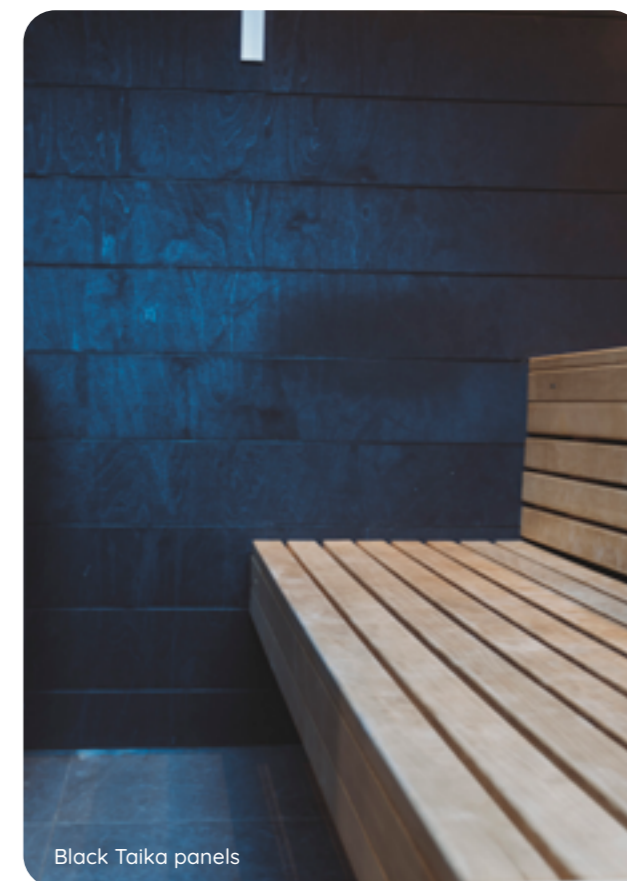

Black Taika panels



Untreated Taika panels

2. Interiors

From traditional interiors to a creative solution. Choose between a range of standard interiors such as Classic, Wide, Slim and Panorama, or explore the option of customised solutions.

Available in aspen, thermo aspen, alder and thermo alder.



Panorama benches



Classic benches



Slim benches

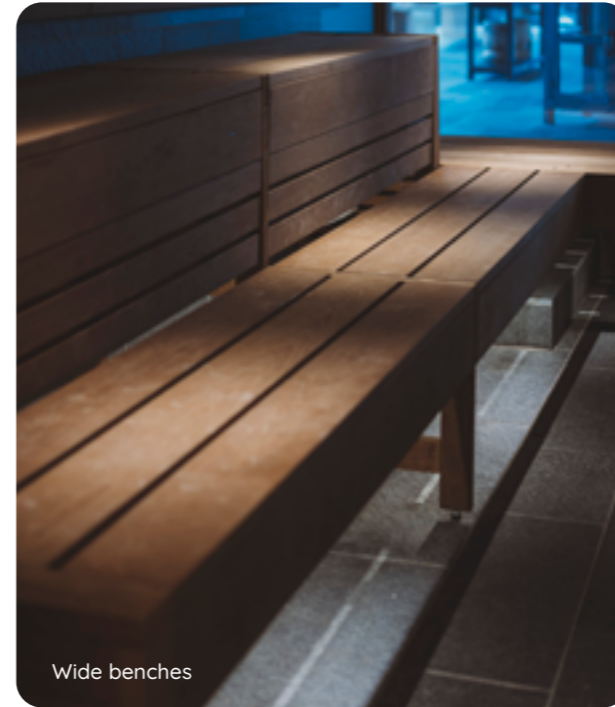

Wide benches



ARMRESTS & SIDE PANELS

For settings where the ends of sauna benches are not fixed against a wall or other support

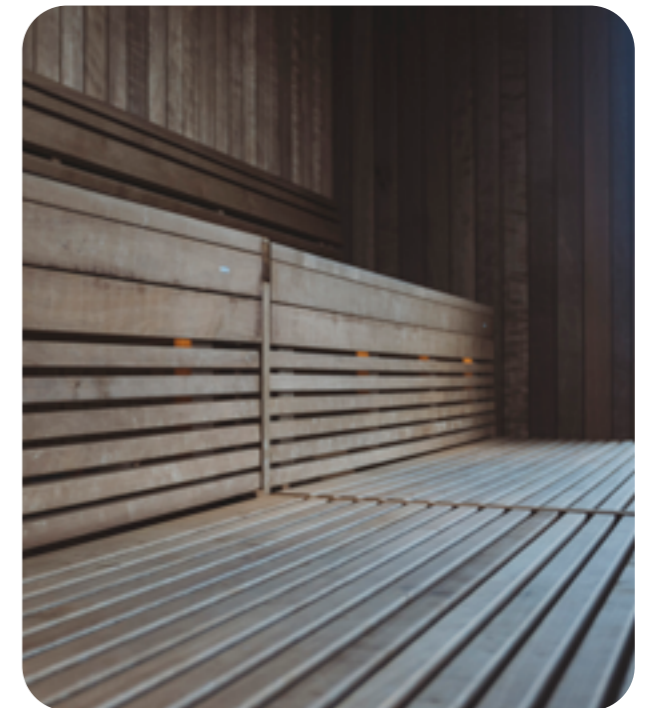

SKIRTING PANELS

Prefabricated skirting panels to eliminate the space between benches.

3. Extras

Add the extra comfort and finish the look with skirting, floor grating, armrests or side panels.



ADJUSTABLE HEADREST
With multiple adjustment options to find the perfect position for your head and neck. Available in alder and aspen



HEADREST
Our sauna headrest is made from high-quality and durable material, making it perfect for use in moist environments. Available in aspen.

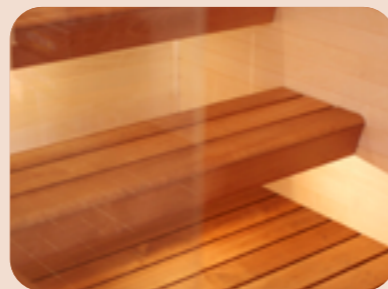

FLOOR GRATING
Grating on the floor feels smooth and pleasant beneath your bare feet and adds a sense of luxury and comfort.



VENTILATION HATCHES
For proper function of your sauna heater and for efficiency and longevity of your sauna, efficient ventilation is a must

4. Glass fronts & corners

There are many possibilities when constructing saunas with our prefabricated glazed sections, crafted from durable safety glass. With a variety of sizes and configurations available, TyLö ensures that each sauna exudes a distinctive contemporary design, making it a standout feature in any setting.





5. Doors

Our top-quality doors are specially manufactured to withstand the considerable temperature differences between the outside and inside of the sauna without warping or deforming.

Want a sauna door with different dimensions or made from different materials? Contact a TyLö dealer for a quote.



1. SAUNA DOOR DGL

An exclusive no-threshold sauna door featuring tempered 8 mm safety glass. The robust aluminium hinges are elegantly encased in stainless steel and the frame is fitted with a magnetic closure.

2. SAUNA DOOR DGB

Robust sauna door made of tempered 8 mm safety glass, with no threshold and a convenient magnetic strip closure on the handle. The standard frame is crafted from pine.

3. DGL/DGB WITH FOUR HINGES

For increased stability, DGB and DGL doors are fitted with four sturdy hinges. These doors have no threshold and offer easy access, including for disabled users due to their generous width.

4. SAUNA DOOR ALU LINE

A stunning sauna door boasting durable tempered safety glass and an attractive design. The exterior features an aluminum handle, while the interior showcases alder strips and a handle. Surrounding the door blade is a stainless steel molding, perfectly complementing the elegant door handle. Available in clear or bronze-tinted glass, the Alu Line door can be ordered as a left or right hung configuration.

More information can be found at [tylo.com](https://www.tylo.com)

6. Lighting

Enhance your sauna experience by selecting the perfect lighting arrangements that best suit your requirements. Whether you prefer a warm and inviting atmosphere with concealed lights tucked under benches and backrests, or seek a more contemporary touch with elegantly placed lamps on the walls or ceiling, we have options that cater to your preferences.



SAUNA SPOTLIGHTS

With these stylish spotlights in black, white or silver you can change the mood in your sauna with just a flick of a switch. These modern spotlights offer both functionality and aesthetics. You can easily install them in the ceiling of your sauna and customise the lighting according to your preference.



1. LED SPOTLIGHT Silver



2. LED SPOTLIGHT White



3. LED SPOTLIGHT Black

WALL & CEILING

Lamps in the ceiling or on the wall allow for creative and customisable lighting solutions that add character and ambience to any sauna room.



1. CLASSIC
Black, frosted glass
Wall-mounted



2. OHM 100/110
Black, frosted glass
Wall-and ceiling-mounted



3. OPUS
Black
Wall-and ceiling-mounted



4. OHM 100/170
Black.
Wall-and ceiling-mounted

CONCEALED LIGHTING



Create the perfect relaxing environment with our discreet concealed lighting. Place behind the backrest or under the benches for a harmonising ambience that transforms your sauna.

SAUNA LED LIGHTING

Lights to place behind the backrest.

STAR LIGHTS



RUBEN SKY LED

Create your own starry sky with our star lights. Ruben sky LED creates a unique atmosphere and elevates your sauna or steam room experience to a whole new level of relaxation. The included control gives you a choice of seven pre-installed programmes or the option of creating your own programme with as many as 20 colour changes.



SAUNA LIGHTING

Silhouette

Silhouette is a luminous series that transforms your sauna in unique ways. With its sleek design and endless possibilities Silhouette challenges the perception of sauna lighting. A revolutionary lighting solution for your sauna, offering endless creative possibilities.

Mix and match your way to perfect lighting with custom combinations! The Silhouette series includes Silhouette Ring and Silhouette Line that each come in three sizes. This variety of options allows you to create a truly unique lighting scheme in your sauna room.

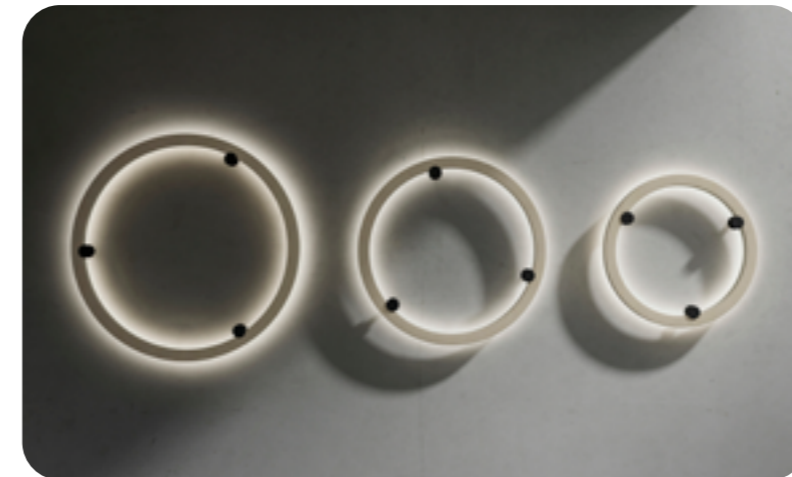

SILHOUETTE RING

The elegant design of Silhouette Ring gives a soft, ambient light that creates the perfect atmosphere in any sauna room. With endless possibilities, it can be hung as a pendant or on the wall, glowing by itself or together with other luminaries from the same series. The lighting is sauna proof and withstands sauna temperatures.

- Ø: 40, 50 & 60 cm
- Available in aspen
- Combine with dimmable infrared sensor (IR EYE) for easy monitoring



SILHOUETTE LINE

Minimalistic Silhouette Line comes in different sizes, allowing you to combine and create your unique sauna lighting. Silhouette Line can be rotated 360 degrees, creating endless combinations to suit the mood of your space. Sauna proof and withstands sauna temperatures.

- L: 40, 120 & 190 cm
- Available in aspen
- Combine with dimmable infrared sensor (IR EYE) for easy monitoring



With a little creativity and imagination, you can use multiple light sources from the series to create unique constellations that add a personal touch to your sauna room.

SAUNA

Heaters



6 Strong reasons to choose Tylö

1. FAST HEATING

Tylö heaters heat your sauna up to twice as fast as other heaters. The advanced IntelliAir™ system, with its dynamic air chambers, ensures optimal and even heat distribution.

2. ENERGY EFFICIENT

All Tylö heaters are equipped with an advanced output functional that automatically reduces power output once a set temperature is reached.

3. SUPERIOR SAFETY - THERMOSAFE

In addition to overheating protection, thermostats and temperature sensors Tylö's heaters come with ThermoSafe™, a unique protective coating to help prevent accidental burns.

4. ENDLESS OPTIONS

Innovation and technical progress has made it possible to customise your sauna experience. With Tylö's combi heaters you can set the temperature and humidity according to your taste and combine as you wish. Read more on page 60.

5. MADE IN SWEDEN

Tylö heaters provide the ultimate sauna experience through considerate Swedish design, in-house production, and meticulous quality control. They give reliable, long-term performance and are a guaranteed worthwhile purchase. Made in Sweden since 1949.

6. HIGH QUALITY

Our commitment to quality is evident in every aspect of our manufacturing process. From the selection of raw materials to the final inspection, we take pride in delivering a superior product.

SAUNA HEATERS

Crown

The Tylo Crown heater lives up to its regal name. From its majestic crown-shaped grill to its impressive lighting pattern, this heater exudes elegance and sophistication. By combining striking visual design with advanced technology, we have created a heater that stands out in form and function. Prepare for a truly memorable sauna experience.



This floor-standing sauna heater has a symmetrical design combined with elegant lighting pattern that casts a warm glow across the room, creating a serene and relaxing ambiance. The eye-catching Crown grill allows optimal airflow and heat circulation throughout the sauna, making sure that you receive the full benefits of the heater's technology.



INTELLIAIR AIR CHAMBERS

IntelliAir air chambers speed up air and heat distribution.

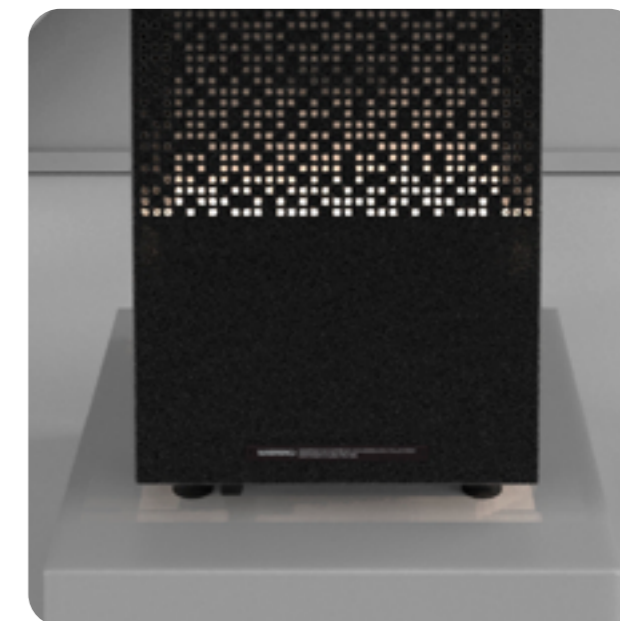

FLOORSTANDING

This floorstanding heater is equally appealing from all sides.



BUILT-IN LIGHTING

This is the first time a sauna heater has built-in lighting.



THERMOSAFE SURFACE

The flocked ThermoSafe surface for safety never gets hotter than 40°C.



For your comfort

Prefer a hot and dry traditional sauna or lower temperature with humidity? Choose between our traditional sauna heaters or our Combi heaters for a Soft Sauna experience and create your ultimate sauna. Available in black and grey as standard options.

DID YOU KNOW?

The Combi version can achieve energy savings of up to 25% compared to traditional heaters by using temperatures of 65-70°C and humidity of 35%.

What's inside

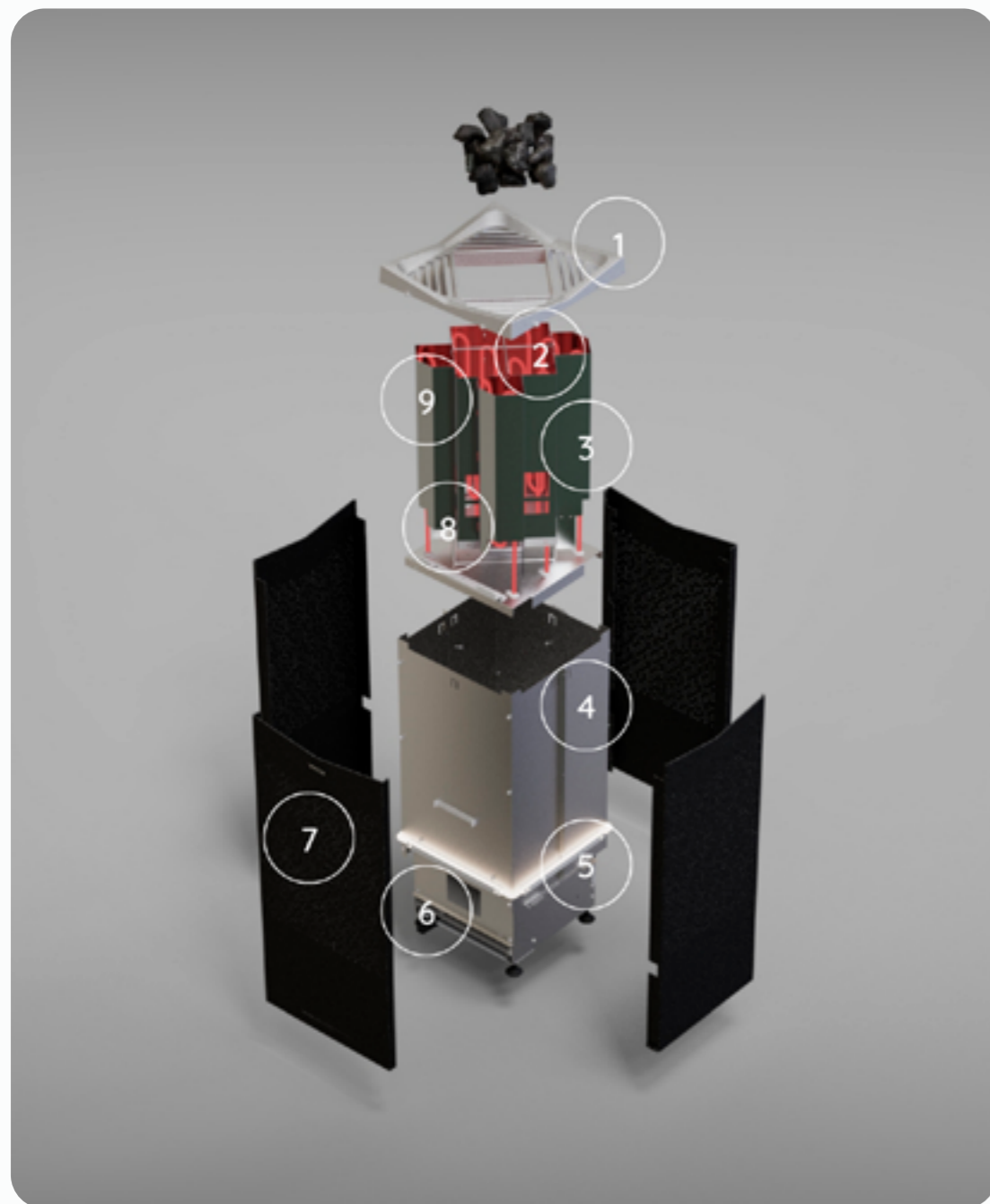

- | | |
|--|--|
| 1. Solid cast aluminum grill | 7. Changeable panels |
| 2. TyLö quality heating element | 8. IntelliAir - stones in the centre surrounded by four air chambers |
| 3. Easier to change the element and container | 9. Large, deep stone container |
| 4. Inner cover for effective heat deflection | |
| 5. Sauna proof neon LED light | |
| 6. Accessibility for easy installation and service | |

Product specification

EASY TO PLACE

- Conveniently placed in a corner, against a wall, or in front of glass
- Features four equally beautiful and visible sides
- Floorstanding

FAST HEATING

- Equipped with IntelliAir air chambers for efficient heating

STONE COMPARTMENT

- Enhanced capacity to hold a full 20 kg of stones
- Deeper compartment allows more time for the water to vaporise

TECH

- Built in electronics – Elite control panel with cloud-based functionality for maximum advantage and comfort
- Built-in lights

INSTALLATION & MAINTENANCE

- Easily accessible without the need to turn the sauna heater around

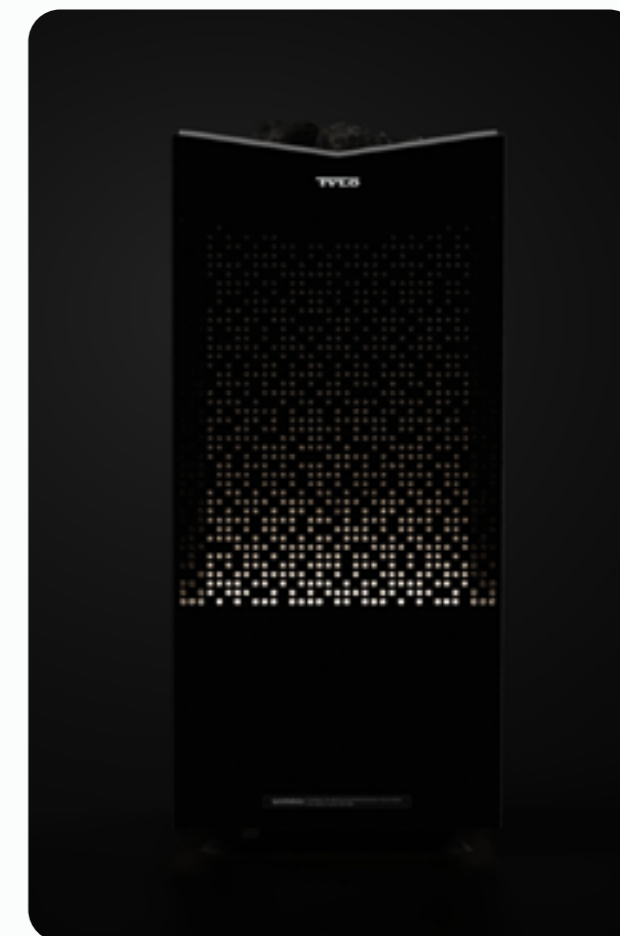

YOUR DREAM SAUNA

At TyLö, we firmly believe in the boundless power of imagination. Is there a specific colour or pattern that resonates with you? Beyond our standard options, we welcome the opportunity to fulfill custom requests. Reach out to a nearby TyLö dealer, and together we can transform creative visions into reality.

Choose your preferred sauna experience



Traditional sauna

THE AUTHENTIC SAUNA EXPERIENCE

Our traditional heaters provide a genuine and authentic sauna experience, offering high heat and low humidity. They are designed to heat the sauna quickly and efficiently, creating a hot and relaxing atmosphere.

Read more on pages 58-59



Soft Sauna

THE TYLÖ EXPERIENCE

Unlike traditional heaters, the Combi heater gives a Soft Sauna experience with the luxury to choose your preferred balance between temperature and humidity. In practice, this means a gentler sauna session with a lower temperature, but with a much higher humidity (up to 70%).

Read more on pages 60-61 and 101

Traditional sauna heaters

Experience a traditional sauna with Tylö traditional heaters. These heaters provide an authentic sauna experience with high heat and low humidity, creating a hot and relaxing atmosphere. Designed to heat up quickly and efficiently, they make the perfect addition to any home!

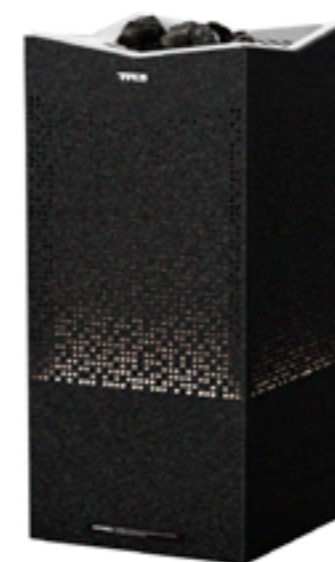

CROWN ELITE

Floorstanding sauna heater with a symmetrical design, elegant lighting pattern, and a Crown-shaped grill for optimal airflow and rapid heat-up. Experience the full benefits of this heater's advanced technology, complete with Elite control panel for effortless operation.



SENSE ELITE/PURE

Sense Elite has the Elite control panel and WiFi connectivity for maximum convenience and comfort. **Sense Pure** is a heater that comes with the Pure control panel for ease of use and convenience. A door contact is required for delayed start.

Our control panels



ELITE

Elite provides exact temperature and humidity control for the Crown and Sense heaters.

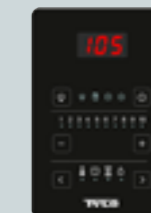

PURE

Comes with the standard digital touch control panel for ease of use and convenience. Lets you set temperature and time.

Read more on pages 62-63



SENSE SPORT

This heater is available in versions with two different power outputs and may be placed on the floor or wall-mounted. The control panel is built into the heater and located at its base.



SENSE SPORT 2/4

This compact sauna heater has been designed to suit smaller scale sauna rooms without compromising style, quality and efficiency. Integrated control panel and ThermoSafe™ protective coating allow for easy setting and improved safety.

Combi sauna heaters

Experience Soft Sauna like never before with the Combi sauna heater! Adjust temperature and humidity to your liking for a gentler, yet indulgent sauna session. Lower temperatures, higher humidity - the ultimate relaxation awaits!

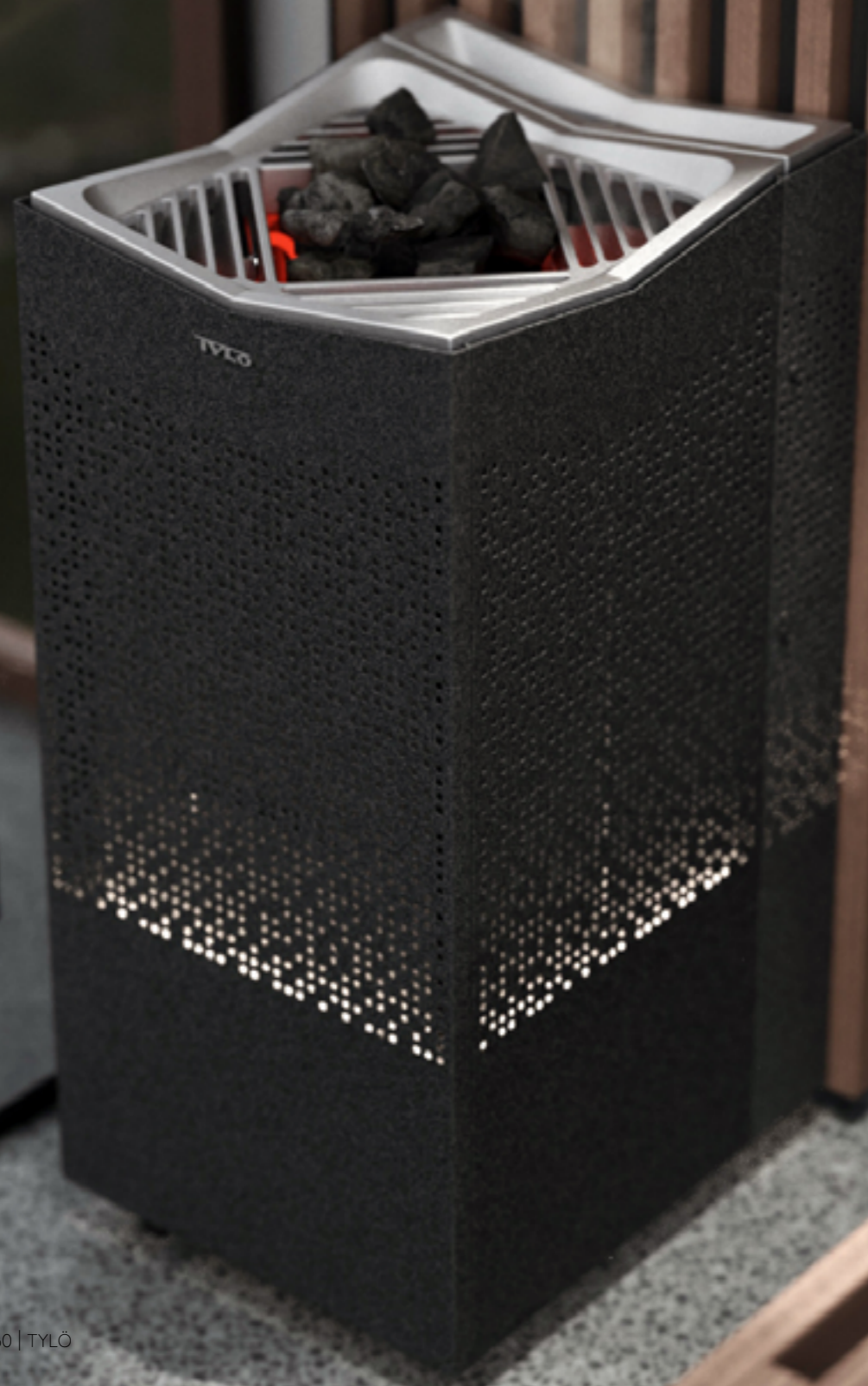

Did you know?

The Combi version can achieve energy savings of up to 25% compared to traditional heaters by using temperatures of 65–70°C and humidity of 35%.



CROWN COMBI ELITE

This sauna heater will add both substance and style to your sauna experience. Crown Combi is the perfect choice with its majestic design, crown-shaped grill, water tank for Soft Sauna experience, and stunning lighting pattern. This heater will make you feel like sauna royalty. Use together with the Elite control panel.



SENSE COMBI ELITE/PURE

Same efficient and swift operation as the rest of the Sense heater lineup, but Sense Combi Pure/Elite delivers traditional dry saunas and saunas with rich and enveloping steam, for an even higher level of versatility and pleasure. The Elite version comes with the Elite control panel with cloud connectivity.



SENSE SPORT COMBI

Enjoy both sauna and steam functionality for a flexible sauna experience in a small package. The Sense Sport Combi 4 heater has an integrated control panel and ThermoSafe™ protective coating for easy setting and improved safety.

Control panels

Effortlessly manage your sauna using our intelligent control panels. The Pure model embodies simplicity and functionality, while the Elite version offers cloud-based functionality and supports multiple user profiles.



Elite

EFFORTLESS BATHING

The Elite control panel has been updated with cloud-based functionality so you can control your sauna from anywhere! Why not have it ready when you come in from the ski slopes or an exhausting car ride on the way home from work.

It is packed with advanced features, thanks to its internal processor and operating system. In addition to personal settings, the Elite can be programmed individually according to your schedule.

Add features such as auxiliary fans, fragrance pumps or lights – the Elite control panel handles it all with clear and concise precision. The 4.5-inch touch screen delivers real-time status on every aspect of your sauna and steam bath. Needs to be completed with a door contact for cloud functionality.



Pure

INTUITIVE DESIGN AND FEATURES

The elegant, compact design of the Pure control panel makes it the go-to choice for those who value functionality and simplicity. The thin black control lets you set the lighting, temperature and sauna time easily with only a few touches.

Of course, choosing the start time up to ten hours in advance means you can step into a wonderfully hot sauna or steam as soon as you get home. (Door contact required).



LOCATING THE CONTROL PANEL

We recommend locating it outside the sauna because of the lower temperature. You can place it in a Tylö Harmony room or a sauna built on-site if the ventilation complies with Tylö's principle of natural draught ventilation, at least 300 mm from the heater and at a maximum height of 800 mm from the floor. If not, place it on the outside of the sauna.

Accessories

JEWEL FRAGRANCE BOWL

Enhance your sauna experience with a stainless steel fragrance bowl. Add essential oils or herbs to create a scented atmosphere. Fits all TyLö heaters and goes particularly well with Crown. Try using it with our essential oils in lemon, peppermint, eucalyptus and lavender.



HEATER GUARD

Elegant wall-mounted guard in ribbed design, combining safety with style. Also available as a corner model in different sizes and wood types to harmonise with your sauna interior.

High quality sauna stones

TYLÖ SAUNA STONES

Genuine heat-retaining vulcanite stones from TyLö. Designed for durability and excellent heat radiation. Placing the stones loosely around the heating elements helps shorten heat-up time and prolong the life of the heater.



Brilliant Silver

Ladle, bucket, hygrometer, thermometer and hourglass



Brilliant Black

Bucket, ladle, hygrometer, thermometer, and hourglass

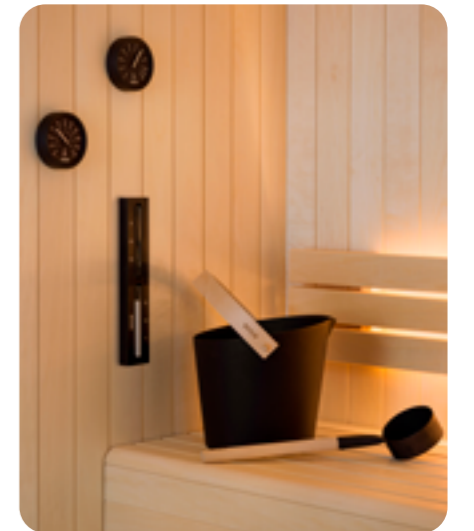

Classic

CLASSIC ACCESSORIES

Ladle, bucket, and hygrometer/thermometer.

CLASSIC GIFT PACK

Contains Classic bucket, ladle, hygrometer/thermometer and sauna fragrance.



Heater stand

Black-painted feet for Sense heaters 6, 8, 10 kW, used when the heater is floor-mounted.

Discover more accessories at [tylo.com](https://www.tylo.com)



STEAM

The heat, the water, the silence and the solitude, a steam bath is the perfect way to relax and let the stressful demands of everyday life fade away. The steam room is our new place for leisure, reflection and well-being. Schedule your steam sessions to be an integral and natural part of your everyday routine!

5 Benefits of steam

1. SKINCARE

Steam stimulates sweating and can help the skin to feel cleaner, softer and rehydrated.

2. RELAXATION & WELLBEING

The mild heat and humidity help create a warm environment able to enhance relaxation and inner balance.

3. MUSCULAR RECOVERY

A steam bath can help the body to relax after physical activity, promoting good circulation.

4. NATURAL CLEANSING

Regular steam baths can support the body's natural processes for cleansing and renewal.

5. REJUVENATION

Steam can help you feel clearer, calmer, and more energised. A natural way to restore body and mind.

Steam showers

Tylö's steam showers are perfect in the modern bathroom and embody a distinct Scandinavian design.

Vista

A sleek looking steam shower enclosure that symbolises Scandinavian design. Vista has matt black, minimalistic profiles used with or without a threshold, to give your bathroom that modern and luxurious look.

The glass walls are smoky grey for an extra graphic effect. The Vista enclosure comes with the Stella steam shower with the advanced Elite control panel that blends perfectly into the black Stella column.



SMART CONTROL PANEL
You control your Vista steam shower with the advanced Elite control panel that blends perfectly into the black Stella column.

Features



RAIN SHOWER
Vista features a ceiling-mounted rain shower head, complemented by a high-quality hand shower integrated into the column.



THE BENEFITS OF AROMA THERAPY
The steam outlet is very quiet and has an aroma compartment on top for you to benefit from aroma therapy.



VISTA TRAY
A minimalist shower tray in anthracite grey or white, designed to complement the Vista steam shower. The tray features a non-slip surface for enhanced safety and an antibacterial coating that makes it easy to clean. It can be installed as a freestanding tray or built in for a seamless look.

STEAM SHOWERS

Stella

The enveloping steam starts in 2 minutes, and soon you have a full, warm steam bath. You control your steam column with the advanced Elite Cloud control panel, which blends perfectly with the black Stella front. The glass front is wider than the column, giving it an enticing floating look. Behind the glass, the LED strip lights add a subtle glow. The hand shower, thermostat and mixer

are of high quality and finished in luxury materials. The steam outlet is very quiet. As standard with Vista, it features a fragrance compartment, allowing you to enjoy the fragrance therapy of your choice. A ceiling-mounted shower head can be connected and controlled from the column. To complete the sleek black look, you can add the matching stool and shelf in black aluminium.



Chrome

Build your own at home steam bath with this modern steam column of true Scandinavian design. The black glass front and the option of chrome, brushed brass or matt black coloured details makes it easy to fit in any tiled shower space.

OPTIONAL DESIGN



Brushed brass



Matt black

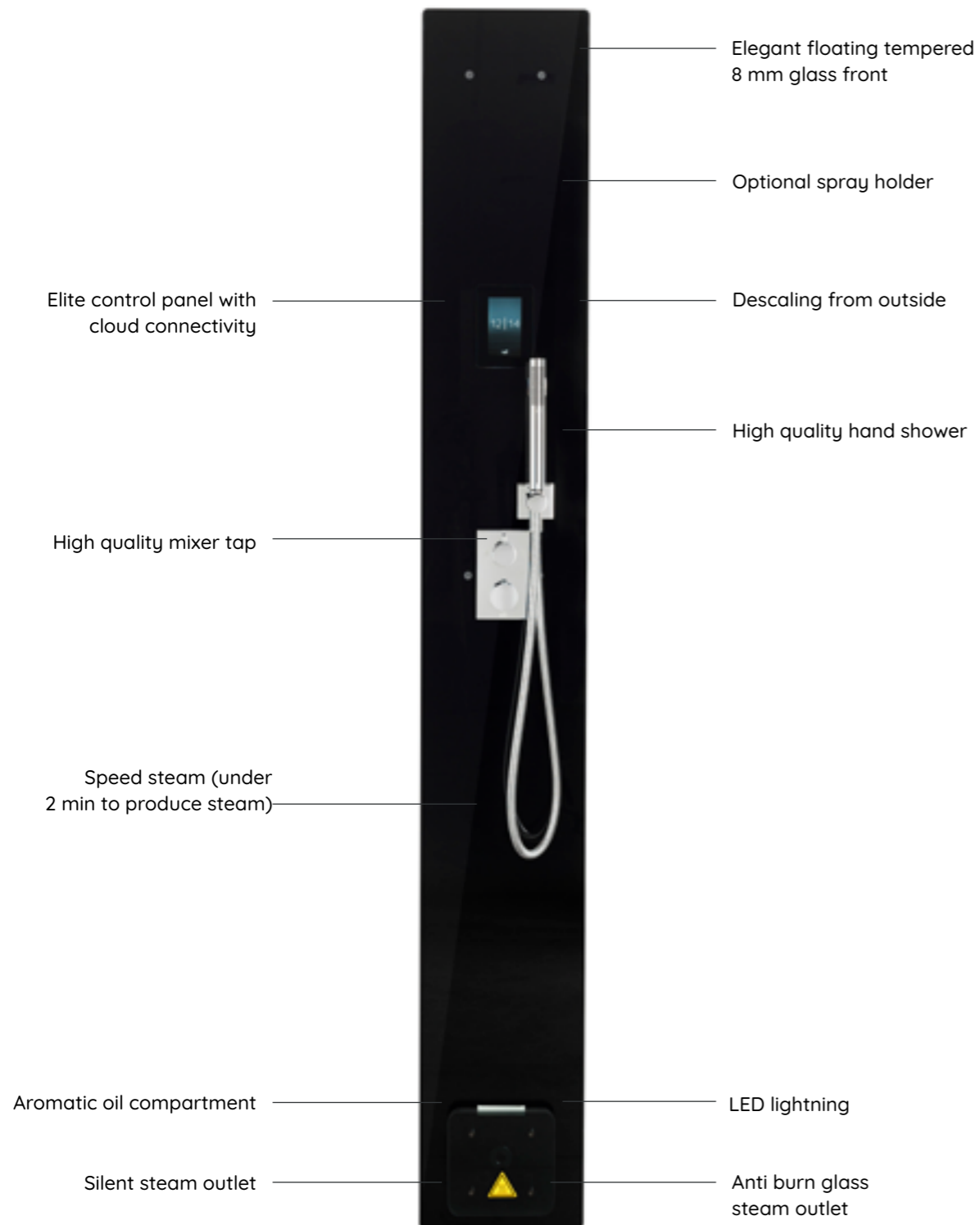

Steam room

Panacea

The Panacea steam bath soothes both body and soul. The hot steam envelops the body, releasing tension and easing muscle aches, while a variety of light settings stimulate the mind to relax. Panacea is available in several different standard sizes and comes with a dramatic back-lit wall.

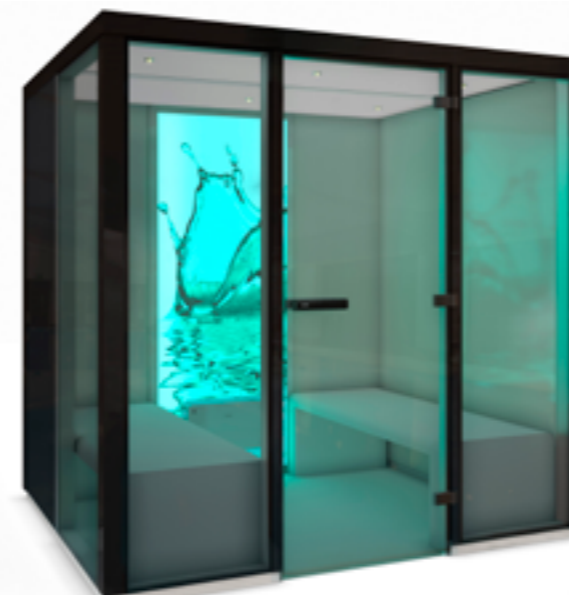

RGB LIGHTING

For a truly personal touch, add RGB lighting. Located in the rear wall and with a declining colour scale meeting the light coming from the steam column. For more lights in the ceiling, spotlights are sold separately.



CORIAN BENCH

Hardwearing and hygienic bench for larger steam rooms.

BENCH 1545

Dimensions: W 1545 x D 600 x H 450 mm

BENCH 1945

Dimensions: W 1945 x D 600 x H 450 mm

BENCH 2345

Dimensions: W 2345 x D 600 x H 450 mm

Find drawings on pages 120-121

Customised steam rooms



4 good things to know when building a steam room

1. MAKE SURE YOUR STEAM GENERATOR IS POWERFUL ENOUGH FOR THE SIZE OF YOUR STEAM ROOM

Choose a powerful steam generator based on your room size. We offer smart versions for both home and commercial use.

2. PRIORITISE PROPER DRAINAGE FOR YOUR STEAM ROOM

Your steam room will need a floor drain for condensation. Place the generator near a drain for easy water disposal as Steam Home and Steam Commercial both automatically discharge remaining water after use.

3. DECIDE MAINTENANCE FREQUENCY IN ADVANCE

Test your mains water hardness to determine maintenance frequency.

4. REGULAR MAINTENANCE FOR COMMERCIAL STEAM ROOMS

The steam generator needs to be descaled regularly at intervals dependent on hours used and water hardness. We recommend installing a Premier Compact water softener for commercial use, to reduce the need for descaling. Daily flushing is necessary in commercial settings.

Doors & glass sections

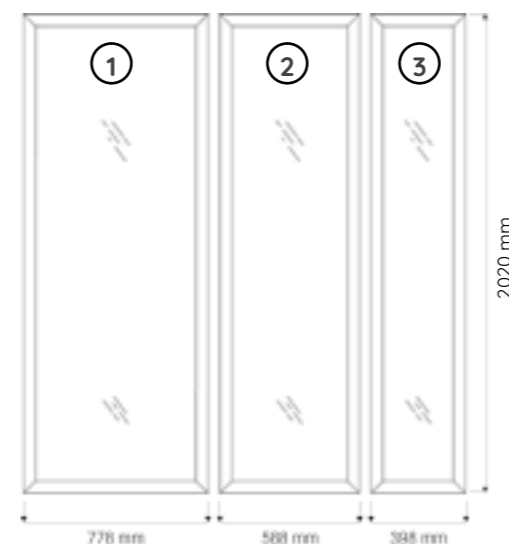

You can achieve your desired width by combining a steam door with your choice of glass sections. Standard for glass section is 60 G profiles

1. **GLASS SECTION 778/2020 BRONZE** Dimensions: 778 x 2020 mm.
2. **GLASS SECTION 588/2020 BRONZE** Dimensions: 588 x 2020 mm.
3. **GLASS SECTION 398/2020 BRONZE** Dimensions: 398 x 2020 mm.



VISTA GLASS FRONT

Customise your steam bath with the VISTA glass front according to your needs. Available in dimensions up to 2400 x 2500 mm. The glass is smoke grey for an extra graphic effect. The front has a frame of matt black aluminum profiles. Even the hinge and handle/knob are in matching matt black aluminium. The front is available with or without a threshold.



1. STEAM DOOR 101 G

Glass steam room door with wheelchair access, no threshold, and wide opening. Available in bronze tinted tempered safety glass, mounted on four hinges for extra strength.



2. STEAM DOOR 60 G

Glass steam room door with magnetic strip closure, available in clear or bronze tinted tempered safety glass. Clean look with aluminum door surround, suitable for left or right-hand installation.



3. STEAM DOOR

Commercial steam room door designed for heavily-used public steam baths. Available in clear or bronze tinted safety glass with thresholdless construction for wheelchair access. Matches DGL/DGB range design to resemble a sauna more closely.

Steam column

The Stella steam shower column in 8 mm black tempered glass with LED lighting, offers swift steam production in two minutes. It features an integrated Elite control panel, a safe and stylish smoke-coloured glass steam nozzle with fragrance bowl, and the option to connect a rain shower.



STELLA STEAM COLUMN

More information on page 70

Steam generators & accessories



STEAM HOME 3/6/9 kW

Our latest compact and effective steam generator for home environments. It offers new and improved features such as stand-by, an aromatherapy option and improved protection against blockages.



FRAGRANCE PUMP

Available as an option for your steam generator and connects simply to the outlet pipe. Add any 5-litre concentrated fragrance. Available in lemon, peppermint, eucalyptus and lavender.



WATER SOFTENER

Effectively reduces water hardness to 1° dH, enhancing reliability and lifespan of steam generators. This automatic unit eliminates the need for manual control or electric timers. By eliminating calcium, it minimizes steam generator descaling, prolonging their lifespan. No electrical connection required, just connect to water supply and drainage for backwash. Ideal for Steam Commercial and Steam Home systems. Utilises salt blocks requiring periodic refills.



BAHIA HOME

The Bahia steam outlet is the obvious choice for form, function and aesthetics. Tempered safety glass design with Corian or high-gloss plastic. Tempered safety glass and high-gloss plastic. Dimensions: W: 280 mm H: 180 mm.

Looking for commercial products? Go to page 92

Accessories

For the Vista experience, add the matching accessories; stools and shelf in matt black aluminum. Or, if you prefer, you can also choose the white Corian stools.



PIXEL STOOL

This stool can be used both inside your Vista steam enclosure or as an attractive stool in your bathroom. Made of aluminium in a softly curved shape, making it comfortable to sit on. The smooth surface is covered in a beautiful matt black powder coating to match the profiles on the Vista.

Size: W 380 x D 330 x H 430

PIXEL SHELF

A small shelf for your shower products or just as a nice decoration. Has the same matt black colour as the profiles on the Vista steam shower enclosure. It can hold up to two kilos and the pattern of the pixels is designed to prevent water accumulating on the shelf.

Size: D: 90 L: 400 mm



CORIAN STOOL

Ergonomic and easily portable stool made out of the hygienic and luxurious material Corian.

Available in sizes:

W 660 x D 310 x H 450 mm

W 350 x D 320 x H 420 mm

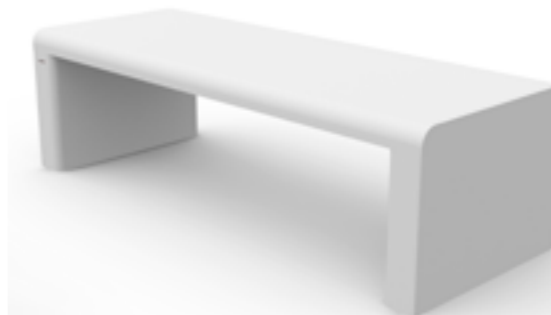

CORIAN BENCH

Hardwearing and hygienic bench for larger steam rooms, made out of the luxurious and hygienic material Corian.

Available in sizes:

W 1545 x D 600 x H 450 mm

W 1945 x D 600 x H 450 mm

W 2345 x D 600 x H 450 mm



INFRARED

5 Benefits of using an infrared sauna

1. RELAXATION

Infrared heat provides a comfortable experience able to help calm the mind and enhance deep relaxation.

2. MUSCLE RESTORATION

Infrared saunas can support recovery after working out by promoting good circulation.

3. WELLBEING

Regular use of infrared saunas can help to improve vitality and a balanced feeling of wellbeing.

4. NATURAL CLEANSING

The infrared heat promotes sweating, which can support the body's natural process of cleansing and renewal.

5. RECOVERY

An infrared sauna session can give a feeling of new energy and clarity, helping you to feel restored and ready for the day.

Choosing an infrared sauna has never been easier

- 1. **ONE PERSON ROOM** Indulge in ultimate relaxation in your private sanctuary.
- 2. **TWO-PERSON ROOM** Share the warmth with a loved one or a friend and enjoy a wonderful experience.
- 3. **THREE-PERSON ROOM** Embrace family time while enjoying infrared heat.

Our models are available in an elegant black finish. They are comfortable with plenty of room. Can't decide? Explore our Combi rooms on pages 90-91 for the best of both worlds!

Experience the many benefits of our infrared rooms with cutting-edge features, including low EMR emissions for safety, an elegant all-glass front wall, adjustable RGBW lighting with dimmer for the perfect ambience along with soothing valance lights and therapeutic colour light therapy. Indulge in a holistic wellness journey like never before!



ONE-PERSON ROOM
The perfect room if you're short of space or just want to sauna alone.
Dimensions: W 913 x D 913 x H 1938 mm



TWO-PERSON ROOM
This popular room is perfect for up to two people.
Dimensions: W 1213 x D 1013 x H 1938 mm



THREE-PERSON ROOM
A combination of great design and superb space efficiency. Ideal for up to three people and fits into almost any corner.
Dimensions: W 1301 x D 1301 x H 1938 mm



THREE-PERSON ROOM
This spacious, elegant infrared room is for up to three people.
Dimensions: W 1633 x D 1078 x H 1938 mm

Features for extra comfort and style

Tylö's infrared sauna comes with a variety of top-class standard features and offers an array of chromotherapy treatments. Come out feeling stronger, healthier and in better balance!



HANDLE
Handle that doubles as a towel rack on the outside and a tablet holder on the inside.



FLOOR
CarbonFlex floor plate with infrared heat, in black to match the panels.

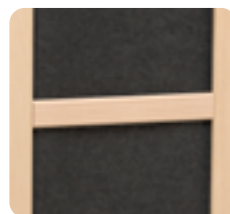

PANEL COLOUR
The IR panels are clad in a sleek black fabric.

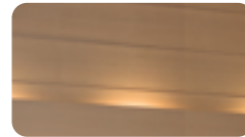

LIGHTING
Indirect lighting for the best relaxation. RGBW for colour choices.



SPEAKERS
Bluetooth® audio



SEATS
Rounded seats for added comfort and legroom.



Enjoy chromotherapy

We all know we need light to live. Especially in the dark winter months. Chromotherapy is about using colours to enhance our health and well-being, with each colour in the spectrum having a different, positive effect on our bodies. Which is your favourite?



ENERGY
The symbol of love and passion. Increases energy and vitality.

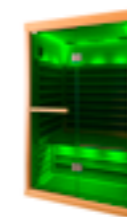

RELAX
Green is harmonic and relaxing, supports balance and love.



CALM
Blue increases calmness, the colour stands for peace and kindness.



CREATIVE
Turquoise helps us become more peaceful, serene and creative.



HAPPY
Yellow is the colour of happiness and high energy, it increases good humour and lightness.



AWARENESS
Violet is the colour of spiritual awareness, it stimulates intuition and imagination.

Smart, intuitive control panel

Lean back with your favourite playlist, relax to your latest audiobook story, or change ceiling colours with just a touch.

- Wi-Fi capability
- Mobile app available
- Intuitive display (time/temp/lighting/system status).
- 60-minute timer.
- Built-in RGBW light control with dimmer.
- Built-in Bluetooth® audio.
- Voice control compliant with Alexa, Google and Siri.

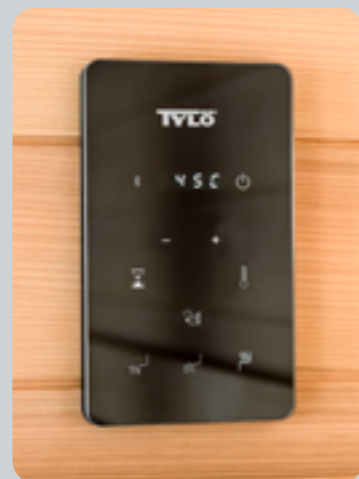



Infrared sauna

The Tylösand Infrared sauna from Tylö consumes only around 1.5-2 kWh per hour of use, making it a highly energy-efficient choice

Along with the many health benefits of an infrared sauna, energy efficiency is another incentive. Infrared technology uses less electricity than many other common household appliances.

Compared to a traditional sauna, the function of infrared is not to heat the air, but rather heat the organic material, your body, in the room. And since you don't wait for an infrared sauna to heat up, you can enjoy its benefits immediately!

Traditional sauna is normally used at temperatures between 65-90°C with an average sauna bath of 1 hour. A smaller sauna room usually consumes about 4-5 kW/h, depending on size, construction and desired temperature. Tylö's infrared room needs approx. 1.5-2 kW/h for 1 hour of use in comparison.



Combination 2 in 1 sauna

Not sure what type of sauna you want? Why not have both? Incorporate our infrared panels into your sauna room, allowing you the flexibility to enjoy a traditional sauna bath or opt for the gentle heat therapy of the infrared panels.

GOT A ROOM YOU RARELY USE THAT COULD BE REPURPOSED?

Craft your personal infrared room! Utilise our varying sizes of infrared panels to fashion the ideal infrared space that suits your needs. Our advanced traditional Tylo sauna system has been seamlessly combined with infrared technology to give you the best of heat.

THREE DIFFERENT TYPES OF PANELS

Choose from three different kinds of loose infrared panels that you can swap for part of the backrest, offering double the amount of sauna joy. Panels are available in black fabric. The fabric panels are made from soft, natural hemlock wood and come in three sizes to fit your space. Combine them in your sauna or use them to build a custom-fitted infrared room.

With our infrared panels, you can set up your infrared room so that you receive warmth on your back, calves, and/or sides. Learn about various uses of infrared panels by scanning the QR code!



More effect, less energy

Infrared saunas use heat waves to heat up your body directly, so you need less heat to get a more intense sweat.

FULL BODY WARMING

Tylo's infrared saunas use exclusive infrared panels that give you the same heat from bottom to top, evenly spread over your body. The panels have a larger heating surface to give you the best in comfort. They spread heat over a wider area to give you the most comfortable surface temperature. They also transmit maximum exposure over the widest possible area to create optimal infrared wavelengths that give you soft, even heat for that perfect sauna experience. And they're probably the safest panels on the market, using our own patented technology.



Power 300 W
W 680 x D 37 x H 980



Power 150 W
W 360 x D 37 x H 980



Power 100 W
W 275 x D 37 x H 980 mm

COMMERCIAL



Your complete partner for commercial sauna projects

Tylö is a trusted partner for commercial sauna projects, with a presence on every continent. Whether you're looking for a traditional sauna, steam room, or infrared warmth, Tylö has you covered. We supply high-quality sauna experiences and complete solutions that add value to your business.

Commercial sauna heaters



SENSE COMMERCIAL

The smaller Sense Commercial heater is available in two power options and is ideal for smaller public sauna spaces. Combine it with the Elite control panel and the relay box Commercial Lite for smooth operation and remote control via Elite Cloud.

6.6 kW – for sauna rooms of 4–8 m³
8 kW – for sauna rooms of 6–12 m³

The larger Sense Commercial heater is available in three power levels and is designed for commercial

sauna environments, but is also suitable for larger private ones. For seamless control, it is combined with the Elite control panel and relay box Commercial. The 10.7 kW model is controlled via the relay box Commercial Lite. Models 10.7–20 kW can also be complemented with a steam generator and steam distributor to create a full Tylarium experience (Soft Sauna).

10.7 kW – for sauna rooms of 10–18 m³
16 kW – for sauna rooms of 15–35 m³
20 kW – for sauna rooms of 22–43 m³



Features ideal for commercial use

IntelliAir™ – Optimised air flow for extra fast heat-up time

ThermoSafe™ – Protective surface that minimises the risk of burns

Ready-at™ – Schedule when the sauna should be warm and ready for use

Elite Cloud – Remote control and monitoring via an app and the cloud service

ELITE CONTROL PANEL

Elite gives you full control of your sauna with cloud connectivity via Elite Cloud. Easily operate and monitor the sauna from the office, reception, or remotely using a mobile device. Features such as energy-saving mode, standby, Ready-at and scheduling make it particularly suitable for commercial environments like spas, hotels, and gyms where high demands are placed on performance and efficiency.



RELAY BOX COMMERCIAL LITE

A compact relay box for controlling heaters up to 10.8 kW. Used with Elite or Pure control panels, it is compatible with the small Sense Commercial model and the Crown Commercial heater. Includes connections for lighting, auxiliary output, and 2100 W infrared control.

RELAY BOX COMMERCIAL

Relay box for the larger Sense Commercial heater, ranging from 16 to 20 kW. Used with Elite or Pure control panels. Equipped with connections for lighting and three auxiliary outputs.



Crown Commercial

Crown Commercial is designed to meet the high standards of spas, hotels, and other sauna environments with intensive use. With its sleek design and dependable performance, it's a trusted choice for professional use. This floor-standing unit features a deep stone compartment that holds up to 20 kg of stones and is equipped with IntelliAir™ technology for rapid heat-up and even heat distribution throughout the sauna room. The surface is coated with ThermoSafe™, providing protection against accidental burns. All service and installation can be carried out from one side, simplifying both setup and maintenance. Integrated LED lighting adds an ambient glow, perfect for exclusive wellness spaces.

8 kW – for sauna rooms of 6–12 m³

10.8 kW – for sauna rooms of 10–18 m³



The unit is controlled using the Elite control panel and relay box Commercial Lite.



ELITE CONTROL PANEL



RELAY BOX COMMERCIAL LITE

Twin Crown Commercial

For larger sauna rooms or when additional power is needed, Twin Crown Commercial is the ideal solution. By combining two Crown Commercial heaters in a synchronised twin installation, you achieve a total output of up to 21.6 kW. This twin configuration ensures consistent steam production by alternating water distribution between two separate stone compartments, each holding 20 kg of stones. The integrated LED lighting adds a distinctive glow that enhances the ambience and overall sauna experience.

16 kW (2x8 kW) – for sauna rooms of 15–35 m³

18.8 kW (8+10.8 kW) – for sauna rooms of 18–40 m³

21.6 kW (2x10.8 kW) – for sauna rooms of 22–45 m³



The units are controlled using the Elite control panel, relay box Pro Control and relay box Pro Power.



ELITE CONTROL PANEL



RELAY BOX PRO CONTROL



RELAY BOX PRO POWER

RELAY BOX PRO

The relay boxes Pro Control and Pro Power 25/45 are designed for sauna environments that require control of multiple heat sources. The system manages both sauna heaters and IR panels in two separate groups, making it particularly suitable for setups such as Twin Crown Commercial or other combined heater and IR installations.



RELAY BOX PRO CONTROL

Control box used with the relay box Pro Control.

Required to control the relay box Pro Power 25 or 45.
Connects to the Elite control panel
Can control up to 2100 W infrared panels directly (Harmony infrared)
2 x Aux outputs
1 x lighting output
Voltage: 200-240 V ~ 10 A



RELAY BOX PRO POWER 25

Contacting box for handling two separate groups of heater and/or infrared panels.

RELAY BOX PRO POWER 45

Larger version of the contactor box, designed for higher power output.

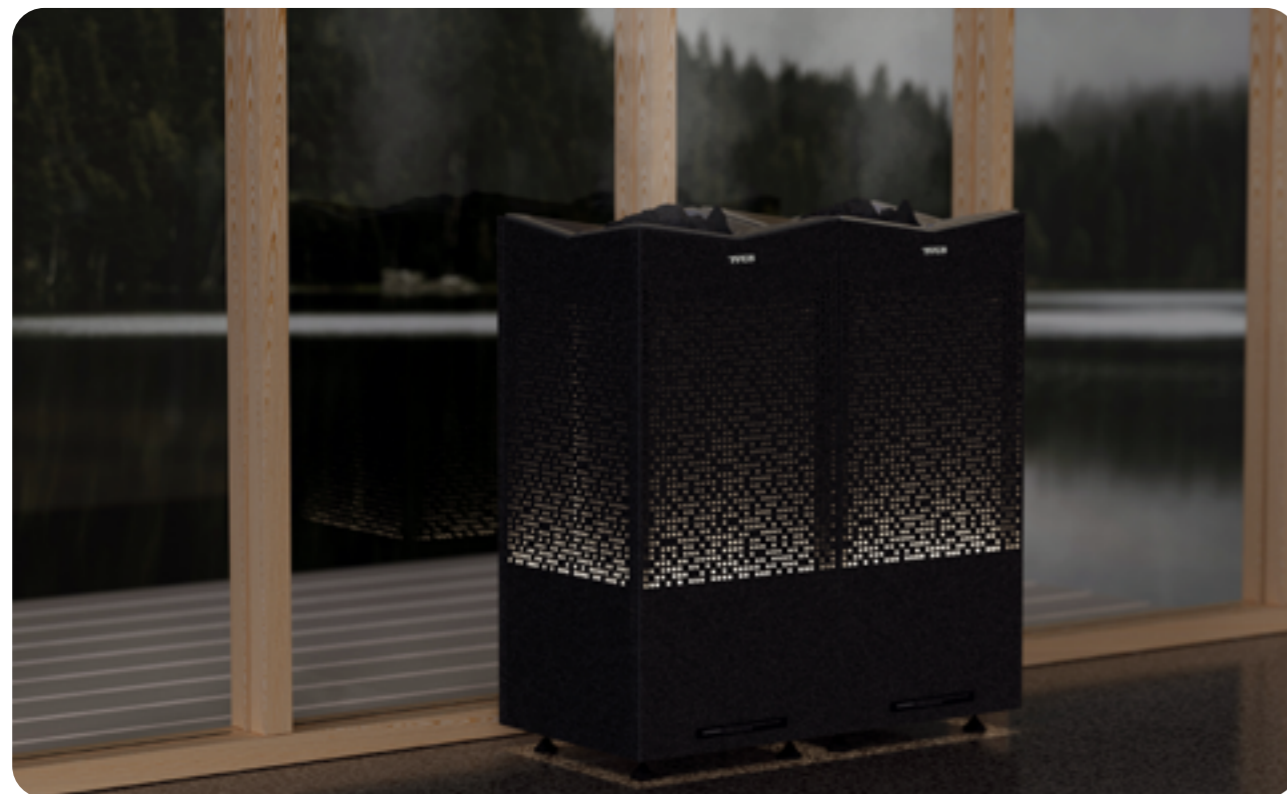

For a complete system overview of control panels, relay boxes and heaters with wiring diagrams and compatibility tables, see pages 116-119

Energy consumption and sauna bathing



Can you save with standby?

Tylö commercial saunas come with a standby function that drops the temperature when not in use. This allows guests to easily heat the sauna to their desired temperature by simply pressing the start button or external switch when they are ready to use it. Our sauna's standby function not only provides convenience for guests to quickly heat the sauna to their desired temperature, but also helps to save energy by reducing the temperature when not in use. This energy-saving feature helps to reduce electricity bills and minimise environmental impact.

EXAMPLE

A Sense Commercial 16 heater, operating 14 hours a day, 365 days a year in a 28 m³ room, and with an average daily standby duration of 3 hours, can result in annual savings of €1524. This calculation is based on an electricity cost of €0.25/kWh.

You are just a few short questions away from learning how standby mode can result in savings for your commercial sauna and steam project.



Scan the QR-code and answer the questions to see how much you can save. Or go to: tylo.com/energy-saving-calculator



Sense Commercial + Steam Commercial = Tylarium

The combination of the Steam Commercial generator, Sense Commercial heater with steam distributor and the Elite control panel makes a Soft Sauna experience possible. This applies even in public or commercial settings. Soft Sauna offers a new way to enjoy both heat and humidity and is a modern version of the traditional sauna.

To control and monitor the sauna from an office or reception area, all you need is Wi-Fi, a device and the Tylö app. The app is specially designed to optimise the sauna experience and is compatible with iOS, Android and desktop devices.



STEAM COMMERCIAL GENERATOR



SENSE COMMERCIAL SAUNA HEATER with steam distributor



ELITE CONTROL PANEL with relay box Commercial and Tylarium Elite Kit*



Prefer hot and dry or combined with mild steam?

TRADITIONAL SAUNA

According to tradition, there are only two versions of the Scandinavian sauna. The classic version is when the temperature lies constantly around 75–90°C with air humidity of around 5–15%. A ladle of water can be poured occasionally on the heater, spreading a comfortable and steamy heat throughout the sauna. A more extreme form of sauna preferred by many Finns is very hot, with a temperature of around 95–110°C, and almost no humidity.

TYLÖ SOFT SAUNA

Soft Sauna is a milder sauna, with a temperature of around 45–65°C. Combined with a humidity level of approximately 30–65%, it creates a mild and soothing sauna experience that suits both adults and children. To enhance the experience, natural herbs or aromatic oils can be added to the steam.

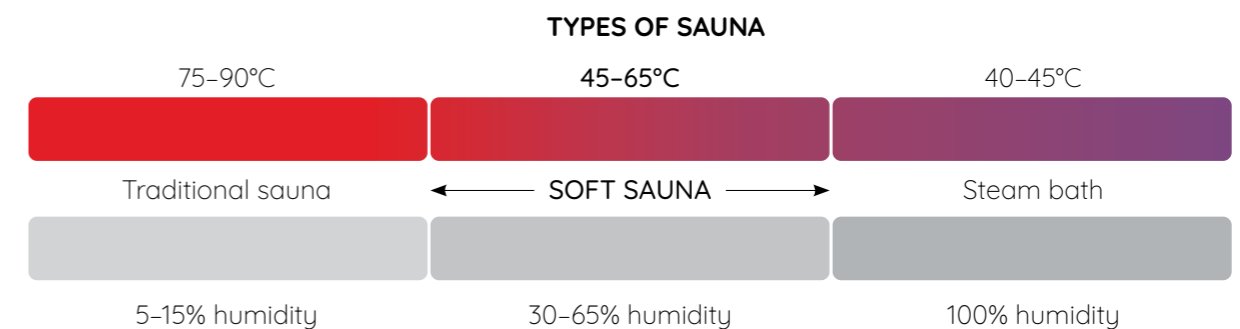



Customised steam rooms

Tylö provides steam generators for commercial use that give a first class steam experience in your spa suite. Customise your steam room according to your own exact specifications and give your guests the ultimate relaxing experience.

Steam generators

Our robust steam generators work reliably and are highly durable, even when used continuously, with minimal maintenance and service costs. They are equipped with multiple practical features for the best sauna experience.



STEAM COMMERCIAL

Our Steam Commercial generator is equipped with a large water tank and is designed for easy connection to our Multi-Steam function - an effective means of avoiding stoppages in systems that are often in use. Available with output of 9/12/15 kW



STEAM OUTLET PRO

Bahia PRO is designed for commercial use. Made of tempered safety glass with Corian, this steam outlet guarantees consistent steam diffusion and low noise levels. Easy to install on a flat wall section. Enhance your steam experience with Bahia PRO.

Select a control panel for your steam generator



ELITE

Allows you to set the exact temperature for complete control. Weekly program and other useful settings for commercial use. Cloud connection for maximum benefits and comfort included.



PURE

Comes with a standard digital touch control panel for ease of use and convenience. Allows you to set temperature and time.



Panacea Twin

A seamless solution combining sauna and steam room.

Panacea Twin offers both a steam bath and a sauna in a seamless Scandinavian design, making it the perfect solution for any commercial environment. The two-in-one sauna room is available in standard sizes with everything included as a complete package, where design flows without compromise. It is easy to install and remove, making it ideal for operations in rented facilities.

See sizes on page 121

REFERENCE PROJECT

Karlatornet

Karlatornet has become a new and iconic landmark in Gothenburg, and is currently the tallest building in Sweden. Tylö was commissioned to design, manufacture and deliver 26 sauna rooms to the apartments and hotel.



Four exclusive penthouse apartments have been built on floors 70 to 74, with saunas fitted with panorama glass fronts, Crown heaters and interiors in thermo aspen. Saunas have also been delivered to another 20 apartments, all individually adapted to match their unique architecture. The hotel's spa has two saunas, one traditional and one hybrid with infrared panels

integrated into the walls. The design was based on drawings from Semrén & Månsson and realised by Tylö with panels and interior fittings in narrow ribbed aspen, shaped details and integrated LED lighting. All saunas were made at Tylö's factory in Halmstad and installed on site with millimeter precision.



REFERENCE PROJECT

Hotel Tylösand

Hotel Tylösand on the coast of south-west Sweden is one of the country's leading spa hotels. The hotel is renowned for its facilities within active leisure and recreation and has a unique approach to health and fitness.



SOFT SAUNA

Hotel Tylösand upgraded its spa with a new commercial sauna adapted for Soft Sauna, a milder sauna experience that Tylo creates with its Tylarium technology. It combines lower temperatures and higher humidity, making it excellent for extended sessions and a wider target group.

The installation includes a Sense Commercial heater with integrated steam generator, Elite control panel and LED lighting. The interiors consist of ribbed panels in thermo-treated alder on a black background and black ceiling in Taika, for a uniform and modern look.

CUTTING EDGE INFRARED THERAPY

Hotel Tylösand now features cutting-edge infrared treatments as part of its wellness range. The incorporation of infrared therapy aligns with the hotel's biohack concept, catering to both recovery and wellbeing. Unlike its previous use for rehabilitation, infrared therapy serves a dual purpose here. This choice reflects the therapy's popularity and synergy with the biohack philosophy, establishing the hotel as a Swedish pioneer in infrared therapy. This step highlights the hotel's dedication to providing top-notch experiences for guests.

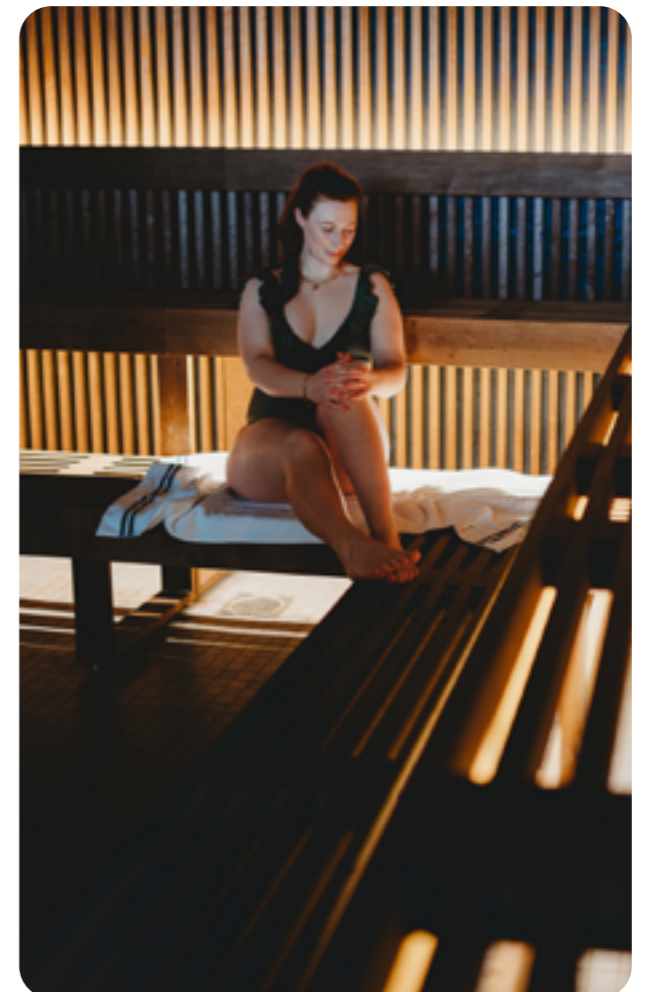

REFERENCE PROJECT

Skepparholmen Nacka



The market for infrared saunas continues to grow explosively and will become a much more common part of modern spa suites. In the process of developing the sauna experience, Skepparholmen Nacka has added a sauna with infrared panels from Tylö.

The spa and conference hotel, Skepparholmen Nacka, presents guests with a stimulating experience. Stunningly located in Stockholm's inner archipelago and with a view over lake Saltsjön, Skepparholmen's spa guests can relax and be seduced by nature.

When a possible renovation was discussed, the objective was to find a complement to the hotel's existing spa facilities, especially a new form of experience for guests. Jenny Strömberg is Spa Manager at Skepparholmen Nacka and had noticed the growing demand for infrared saunas:

"Our ambition was to complement our spa with something new to care for our guests."

"We wanted to renew our spa experience and had noticed that infrared saunas have become very popular. Our ambition was to complement our spa with something new to care for our guests. It's great to see how appreciated our newly-installed infrared sauna is amongst our guests."



With the hotel's close proximity to nature in mind, Tylö created a warm, enveloping environment in which the contrasts between the materials used symbolise a natural and modern design. The result was black Taika panels combined with a slimline interior in alder.

The interior features Tylö Slim in alder with decorative skirting panels. It adds character to the space and complements the infrared panels on the walls.

Because the infrared panels heat the body directly, the overall room temperature is balanced by a heater that maintains a consistent 45 °C. This is essential in larger rooms to enhance the overall experience.

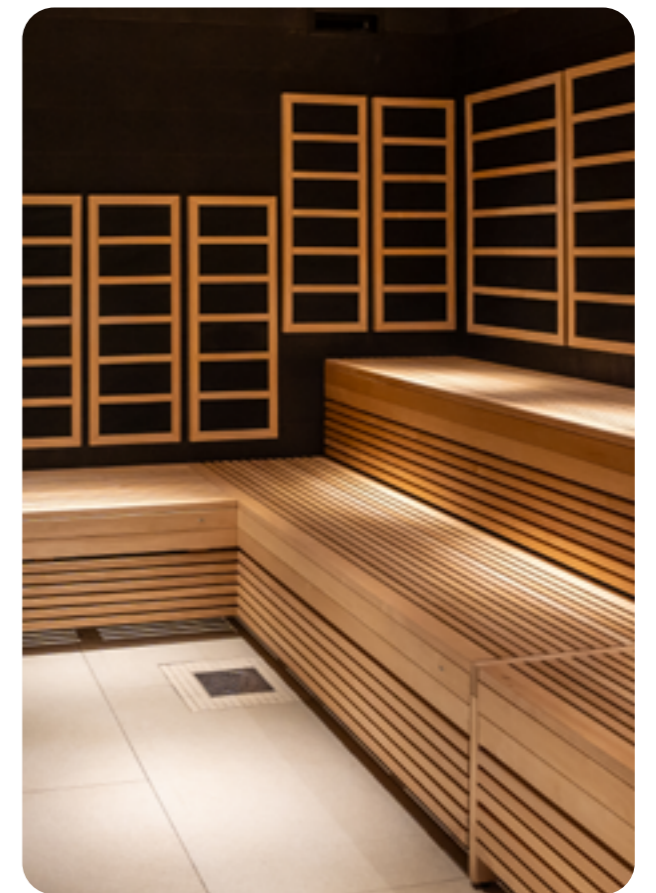

What's the difference between an infrared and a traditional sauna?

An infrared sauna uses light in infrared wavelengths to heat the body. It heats the person in the sauna rather than the air, as is the case in a traditional sauna. An infrared sauna is therefore perceived as gentler and milder than a traditional sauna and is an excellent alternative if you find a traditional sauna too hot. It gives the same feeling of relaxation and sweating as a traditional sauna, but with a softer and more comfortable heat.

REFERENCE PROJECT

Calmar Stadshotell

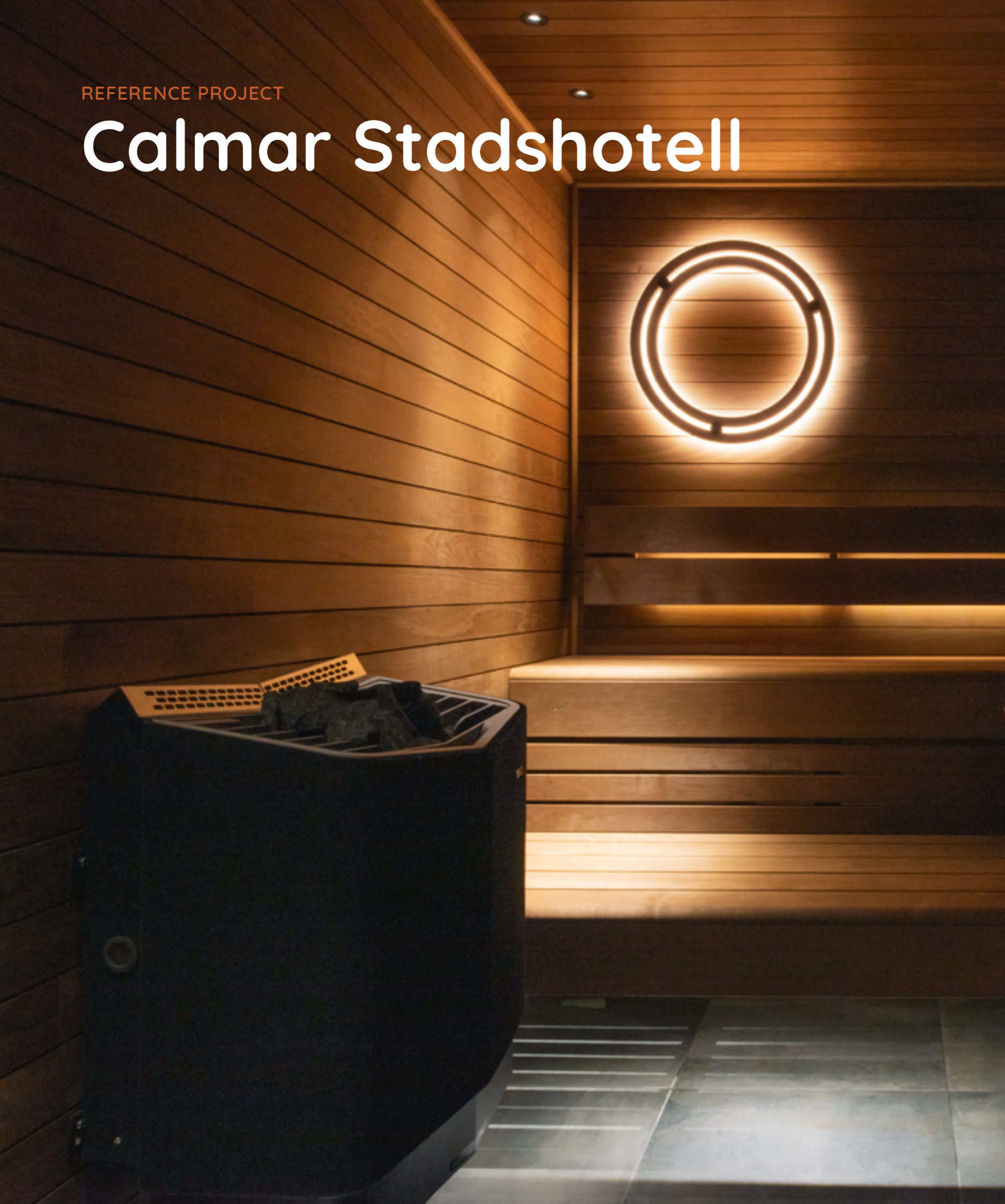

These beautifully designed saunas boast a unique combination of materials and lighting, creating a sleek and modern ambience. Thermo aspen and thermo alder, both high-quality woods, are seamlessly integrated into the hotel's design, creating a warm and inviting atmosphere throughout.

The interiors are carefully crafted with different panel expressions, ranging from slimmer profiles to wider formats that bring lightness and character to the overall appearance of the spaces. Creative and refined lighting solutions enhance the design, illuminating the saunas in a way that sets a calm and balanced mood.

Every detail has been thoughtfully considered and professionally executed. The result is a sauna experience that feels both comfortable and luxurious, where high-quality materials and attention to detail create an environment dedicated to relaxation and well-being.



Home use

HOME ELECTRIC SAUNA HEATERS

Product	Output (kW)	Sauna volume (m ³)	Weight of heater + stones (kg)	Dimensions (W x D x H)	Safety distance				Suitable control panel	Installation
					Side (mm)	Front (mm)	Ceiling (mm)	Floor (mm)		
Crown Combi Elite 6	6.6	4-8	34 + 20	362 x 441 x 805	50	30	1900		Elite included	Floorstanding
Crown Combi Elite 8	8	6-12	34 + 20	362 x 441 x 805	50	30	1900		Elite included	Floorstanding
Crown Combi Elite 10	10.8	10-18	34 + 20	362 x 441 x 805	50	30	1900		Elite included	Floorstanding
Sense Sport Combi 4	4.5	2-4	13.4 + 7	348 x 274 x 490	20	30	1900	170	Built-in	Wall mounted
Sense Combi Pure 6	6.6	4-8	25 + 20	435 x 375 x 620	110	30	1900	100	Pure included	Wall mounted or floorstanding*
Sense Combi Pure 8	8	6-12	25.5 + 20	435 x 375 x 620	110	30	1900	100	Pure included	Wall mounted or floorstanding*
Sense Combi Pure 10	10.5	10-18	25.5 + 20	435 x 375 x 620	110	30	1900	100	Pure included	Wall mounted or floorstanding*
Sense Combi Elite 6	6.6	4-8	25 + 20	435 x 375 x 620	110	30	1900	100	Elite included	Wall mounted or floorstanding*
Sense Combi Elite 8	8	6-12	25.5 + 20	435 x 375 x 620	110	30	1900	100	Elite included	Wall mounted or floorstanding*
Sense Combi Elite 10	10.5	10-18	25.5+ 20	435 x 375 x 620	110	30	1900	100	Elite included	Wall mounted or floorstanding*

HOME ELECTRIC SAUNA HEATERS

Product	Output (kW)	Sauna volume (m ³)	Weight of heater + stones (kg)	Dimensions (W x D x H)	Safety distance				Suitable control panel	Installation
					Side (mm)	Front (mm)	Ceiling (mm)	Floor (mm)		
Crown Elite 6	6.6	4-8	27.5 + 20	362 x 362 x 805	50	30	1900		Elite included	Floorstanding
Crown Elite 8	8	6-12	28 + 20	362 x 362 x 805	50	30	1900		Elite included	Floorstanding
Crown Elite 10	10.8	10-18	28 + 20	362 x 362 x 805	50	30	1900		Elite included	Floorstanding
Sense Pure 6	6.6	4-8	18 + 20	435 x 375 x 600	110	30	1900	100	Pure included	Wall mounted or floorstanding*
Sense Pure 8	8	6-12	18.5 + 20	435 x 375 x 600	110	30	1900	100	Pure included	Wall mounted or floorstanding*
Sense Pure 10	10.5	10-18	18.5 + 20	435 x 375 x 600	110	30	1900	100	Pure included	Wall mounted or floorstanding*
Sense Elite 6	6.6	4-8	19 + 20	435 x 375 x 600	110	30	1900	100	Elite included	Wall mounted or floorstanding*
Sense Elite 8	8	6-12	19.5 + 20	435 x 375 x 600	110	30	1900	100	Elite included	Wall mounted or floorstanding*
Sense Elite 10	10.5	10-18	19.5 + 20	435 x 375 x 600	110	30	1900	100	Elite included	Wall mounted or floorstanding*

HOME ELECTRIC SAUNA HEATERS

Product	Output (kW)	Sauna volume (m ³)	Weight of heater + stones (kg)	Dimensions (W x D x H)	Safety distance				Suitable control panel	Installation
					Side (mm)	Front (mm)	Ceiling (mm)	Floor (mm)		
Sense Sport 2/4	2.2-4.5	2-4	9.3 + 7	348 x 214 x 480	20	30	1900	170	Built-in	Wall mounted
Sense Sport 6	6.6	4-8	17.3 + 20	435 x 375 x 600	110	30	1900	100	Built-in	Wall mounted or floorstanding*
Sense Sport 8	8	6-12	17.5 + 20	435 x 375 x 600	110	30	1900	100	Built-in	Wall mounted or floorstanding*

*Feet for floorstanding Sense sold separately.

STEAM GENERATORS

Model	Item no.	Output (kW)	Steam room min./max. volume (m ³)				Steam production (kg/h)	Dimensions in mm (W x D x H)	Suitable control panel
			Light wall made of glass, plastic, etc.		Heavy wall made of tiles, concrete, stone, etc.				
			With ventilation	Without ventilation	With ventilation	Without ventilation			
Steam Home	66210120	3 6 9	- 3-8 6-16	max. 3 4-15 13-24	- 2-5 4-10	max. 2 2.5-8 7-16	3.5 8 12	480 x 159 x 615	Elite + Pure

To be installed away from steam in a dry and vented space.

Commercial heaters

COMMERCIAL ELECTRIC SAUNA HEATERS

Product	Output (kW)	Sauna volume (m ³)	Weight of heater + stones (kg)	Dimensions (W x D x H)	Safety distance		Safety distance			Suitable control panel	Installation
					Side (mm)	Front (mm)	Ceiling (mm)	Floor (mm)			
Sense Commercial 6	6.6	4-8	17 + 20	431 x 375 x 600	110		30	1900	100	Pure or Elite with relay box Commercial Lite	Wall mounted or floorstanding*
Sense Commercial 8	8	6-12	17.5 + 20	431 x 375 x 600	110		30	1900	100	Pure or Elite with relay box Commercial Lite	Wall mounted or floorstanding*
Sense Commercial 10	10.7	10-18	32 + 25	650 x 400 x 650	150		200	1900	270	Pure or Elite with relay box Commercial Lite	Wall mounted
Sense Commercial 16	16	15-35	32 + 25	650 x 400 x 650	150		200	2100	270	Pure or Elite with relay box Commercial	Wall mounted
Sense Commercial 16.3 x 230V	16	15-35	32 + 25	650 x 400 x 650	150		200	2100	270	Pure or Elite with relay box Commercial	Wall mounted
Sense Commercial 20	20	22-43	32 + 25	650 x 400 x 650	150		200	2100	270	Pure or Elite with relay box Commercial	Wall mounted
Sense Commercial 20.3 x 230V	20	22-43	32 + 25	650 x 400 x 650	150		200	2100	270	Pure or Elite with relay box Commercial	Wall mounted
Crown Commercial 8	8	6-12	26 + 20	362 x 362 x 805	50		30	1900		Elite with relay box Commercial Lite	Floorstanding
Crown Commercial 10	10.8	10-18	26 + 20	362 x 362 x 805	50		30	1900		Elite with relay box Commercial Lite	Floor standing
Twin Crown Commercial 16	8 + 8	15-35	52 + 40	724 x 362 x 805	50		30	2100		Elite with relay boxes Pro Control & Pro Power	Floorstanding
Twin Crown Commercial 18.8	10.8 + 8	18-40	52 + 40	724 x 362 x 805	50		30	2100		Elite with relay boxes Pro Control & Pro Power	Floorstanding
Twin Crown Commercial 21.6	10.8 + 10.8	22-45	52 + 40	724 x 362 x 805	50		30	2100		Elite with relay boxes Pro Control & Pro Power	Floorstanding

*Feet for floorstanding Sense sold separately.

TYLARIUM

Sauna volume (m ³)	Sauna heater kW	Relay box	Steam generator kW	Control panel	Necessary	Optional
10-18	Sense Commercial 10	Commercial Lite	Steam Commercial 9	Elite	Tylarium Elite Kit item number 71016000	Steam Distributor Commercial 90029263
15-35	Sense Commercial 16	Commercial	Steam Commercial 9	Elite	Tylarium Elite Kit item number 71016000	Steam Distributor Commercial 90029263
22-43	Sense Commercial 20	Commercial	Steam Commercial 12	Elite	Tylarium Elite Kit item number 71016000	Steam Distributor Commercial 90029263

COMMERCIAL

Dimensions of sauna room for commercial use with corresponding heater output in kilowatt (kW)*

Heater model	4-8 m ³	6-12 m ³	10-18 m ³	15-35 m ³	18-40 m ³	22-43 m ³	22-45 m ³
Sense Commercial 6	6.6						
Sense Commercial 8		8.0					
Crown Commercial 8		8.0					
Sense Commercial 10			10.7				
Crown Commercial 10			10.8				
Sense Commercial 16				16			
Twin Crown Commercial 16				8 + 8			
Twin Crown Commercial 18.8					10.8 + 8		
Sense Commercial 20						20	
Twin Crown Commercial 21.6							10.8 + 10.8

* Note: if the sauna room has glass or tile/stone walls, add 1-2 m³ to the room volume for each m² of heavy materials.

STEAM GENERATORS

Model	Item no.	Output (kW)	Steam room min./max. volume (m ³)				Steam production (kg/h)	Dimensions in mm (W x D x H)	Suitable control panel
			Light wall in glass, plastic etc.		Heavy wall in tiles, concrete, stone, etc.				
			With ventilation	Without ventilation	With ventilation	Without ventilation			
Steam Commercial	66210150	9	6-16	13-24	4-10	7-16	12	585 x 230 x 685	Elite + Pure
	66210152	12	14-22	22-30	8-15	14-20	16		
	66210154	15	18-25	28-38	10-19	18-25	20		
2 x 9 2 x 12 2 x 15 Steam Commercial		18	20-30	28-40	13-20	18-30	24		Elite
		24	28-40	38-50	18-30	28-40	32		
		30	36-50	56-76	32-42	42-57	40		
3 x 9 3 x 12 3 x 15 Steam Commercial		27	38-45	46-60	28-40	38-52	36		Elite
		36	43-60	58-70	38-50	48-60	48		
		45	54-75	84-114	47-63	60-75	60		

To be installed away from steam in a dry and vented space.

Compatibility between commercial sauna heaters and relay boxes

400 V 3N~	Sense 6	Sense 8	Sense 10	Sense 16	Sense 20	Crown 8	Crown 10	Twin Crown 16	Twin Crown 18.8	Twin Crown 21.6
Relay Box Commercial Lite	X	X	X			X	X			
Relay Box Commercial	X	X	X	X	X	X	X			
Relay Box Pro Power 25								X	X	X
Relay Box Pro Power 45								X	X	X
200-230 V 3~										
Relay Box Commercial Lite	X	X	X			X	X			
Relay Box Commercial	X	X	X	X	X	X	X			
Relay Box Pro Power 25								X		
Relay Box Pro Power 45								X	X	X
200-230 V~										
Relay Box Commercial Lite	X	X				X				
Relay Box Commercial	X	X				X				
Relay Box Pro Power 25								X		
Relay Box Pro Power 45								X		

Capacity - Relay Box Pro Power 25 & 45

Area of use	Relay Box Pro Power 25 Amp	Relay Box Pro Power 45 Amp
For heater (per group)	Max. 15 kW at 400-415 V 3~ Max. 8 kW at 200-230 V 3~ Max. 8 kW at 200-230 V~	Max. 15 kW at 400-415 V 3~ Max. 15 kW at 200-230 V 3~ Max. 8 kW at 200-230 V~
For infrared panels (per group)	Max. 6.9 kW at 400-415 V 3N~ Max. 3.9 kW at 200-230 V~	Max. 6.9 kW at 400-415 V 3N~ Max. 3.9 kW at 200-230 V~

Overview of commercial sauna systems

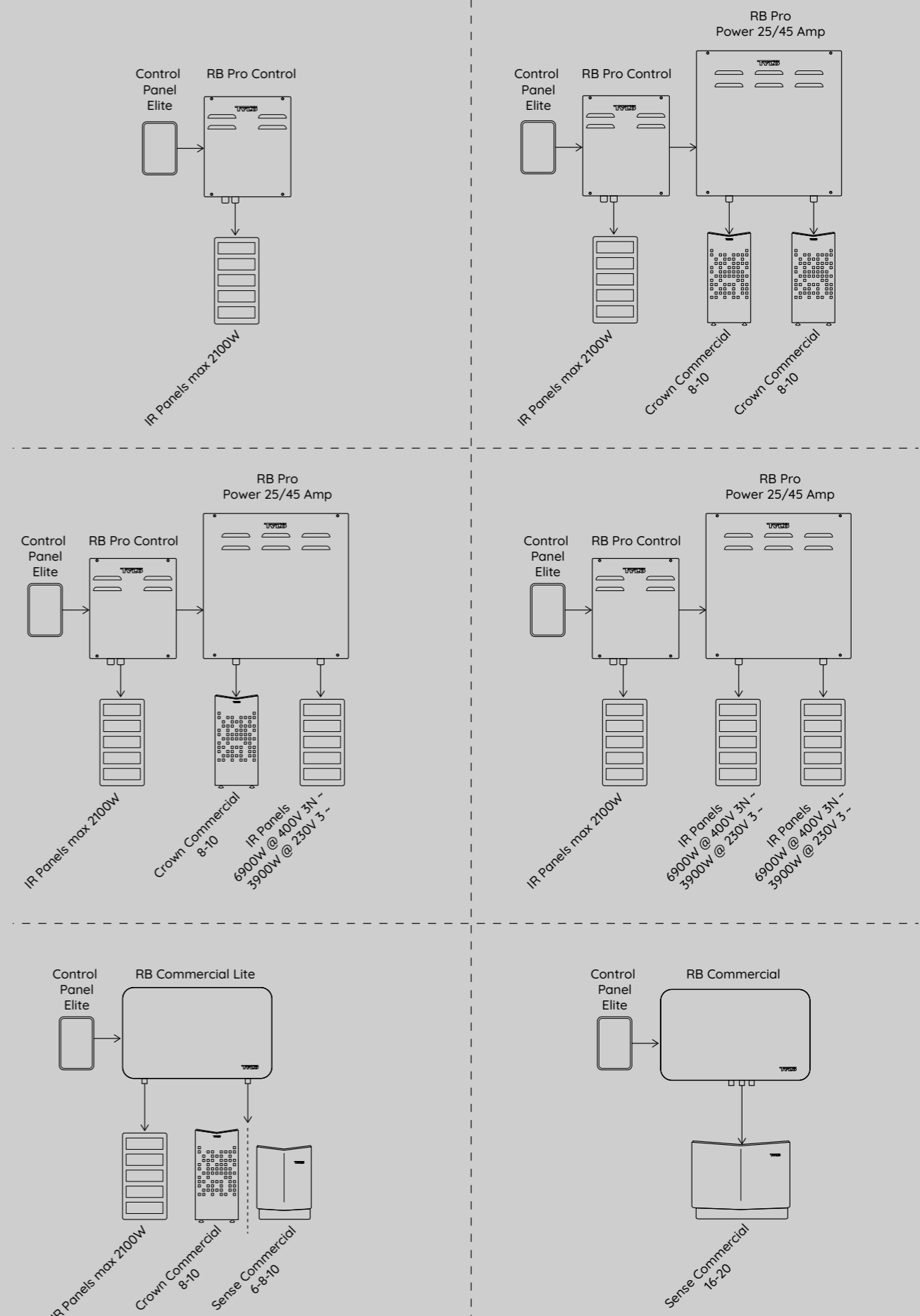

Technical information & drawings

Panacea pages 72-73

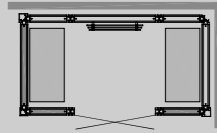

PANACEA 1709
Dimensions: 1725 x 925 x 2090 mm

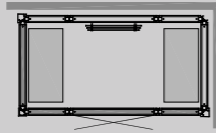

PANACEA 1709 T
Dimensions: 1725 x 925 x 2090 mm

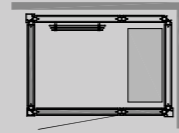

PANACEA 1309 T
Dimensions: 1325 x 925 x 2090 mm

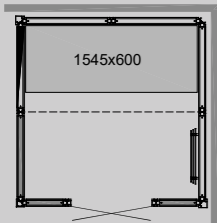

PANACEA 1717 1B
Dimensions: 1725 x 1725 x 2090 mm

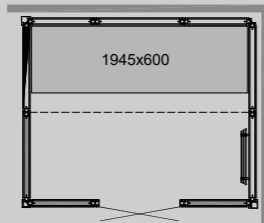

PANACEA 2117 1B
Dimensions: 2125 x 1725 x 2090 mm

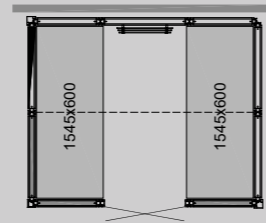

PANACEA 2117 2B
Dimensions: 2125 x 1725 x 2090 mm

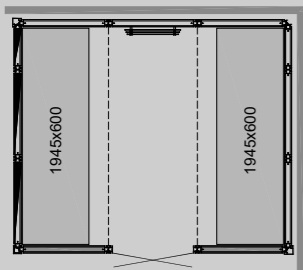

PANACEA 2521 2B
Dimensions: 2525 x 2125 x 2090 mm

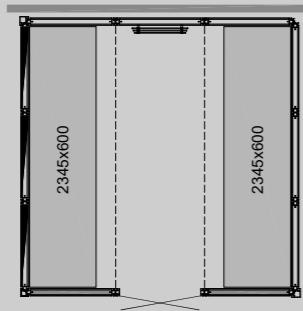

PANACEA 2525 2B
Dimensions: 2525 x 2525 x 2090 mm

1717, 2117 and 2525 can be supplied with wheelchair-adapted door (930 mm opening).

Panacea Twin pages 98-99

Alt. 1 - Located in right corner,

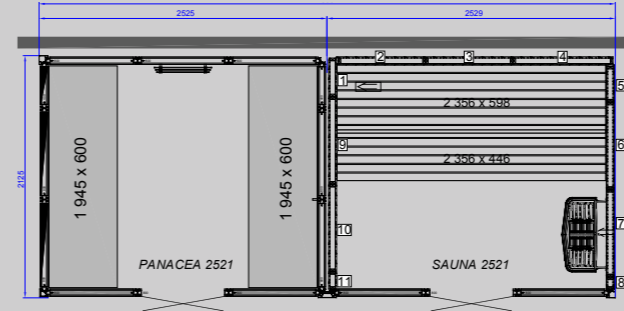

TWIN PANACEA 2521
Dimensions: D 2125 x W 5054 mm

Alt. 1 - Located in right corner,

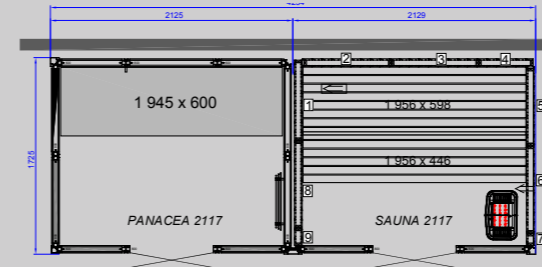

TWIN PANACEA 2117
Dimensions: D 1725 x W 4254 mm

Alt. 1 - Located in right corner, Panacea door located in front

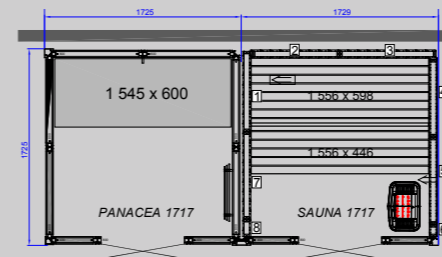

TWIN PANACEA 1717
Dimensions: D 1725 x W 3454 mm

Technical information & drawings

Infrared p. 82-89

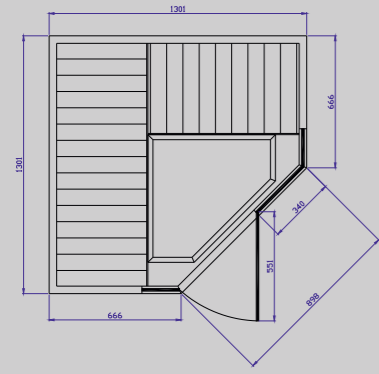

TYLÖSAND T-870
Dimensions: D 1301 x W 1301 mm
Output: 1600 W

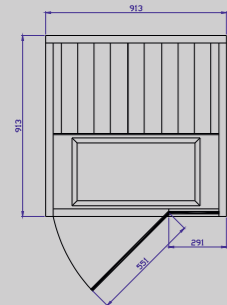

TYLÖSAND T-810
Dimensions: D 913 x W 913 mm
Output: 1350 W

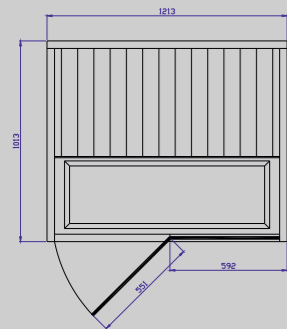

TYLÖSAND T-820
Dimensions: D 1013 x W 1213 mm
Output: 1470 W

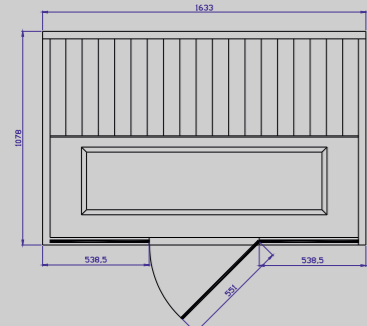

TYLÖSAND T-825
Dimensions: D 1078 x W 1633 mm
Output: 1980 W

Vista p. 68-69

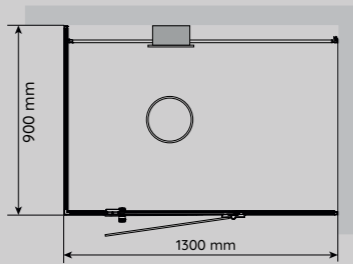

VISTA 130 LEFT
Dimensions: D 900 x W 1 300 mm

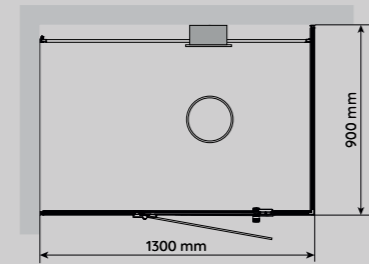

VISTA 130 RIGHT
Dimensions: D 900 x W 1 300 mm

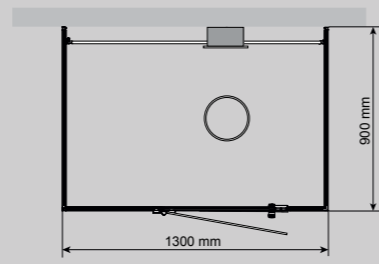

VISTA DCO 130 RIGHT
Dimensions: D 900 x W 1300 mm

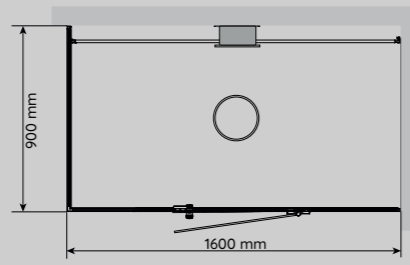

VISTA 160 LEFT
Dimensions: D 900 x W 1 600 mm

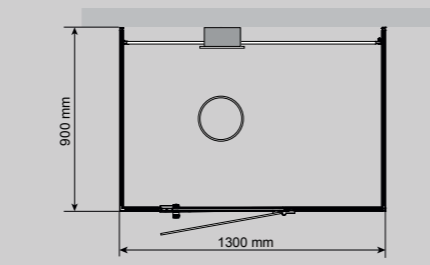

VISTA DCO 130 LEFT
Dimensions: D 900 x W 1 300 mm

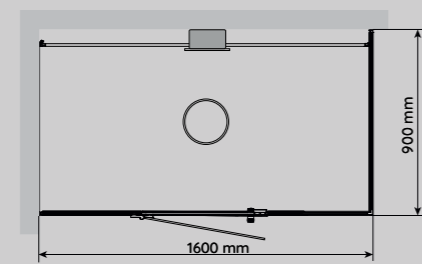

VISTA 160 RIGHT
Dimensions: D 900 x W 1 600 mm

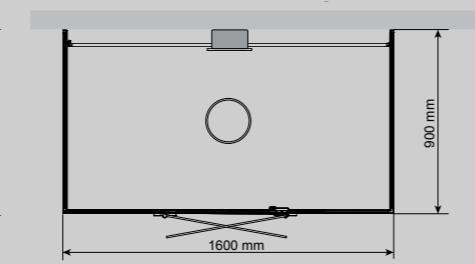

VISTA DCO 160 (LEFT & RIGHT)
Dimensions: D 900 x W 1 600 mm

Reflection p. 12-15

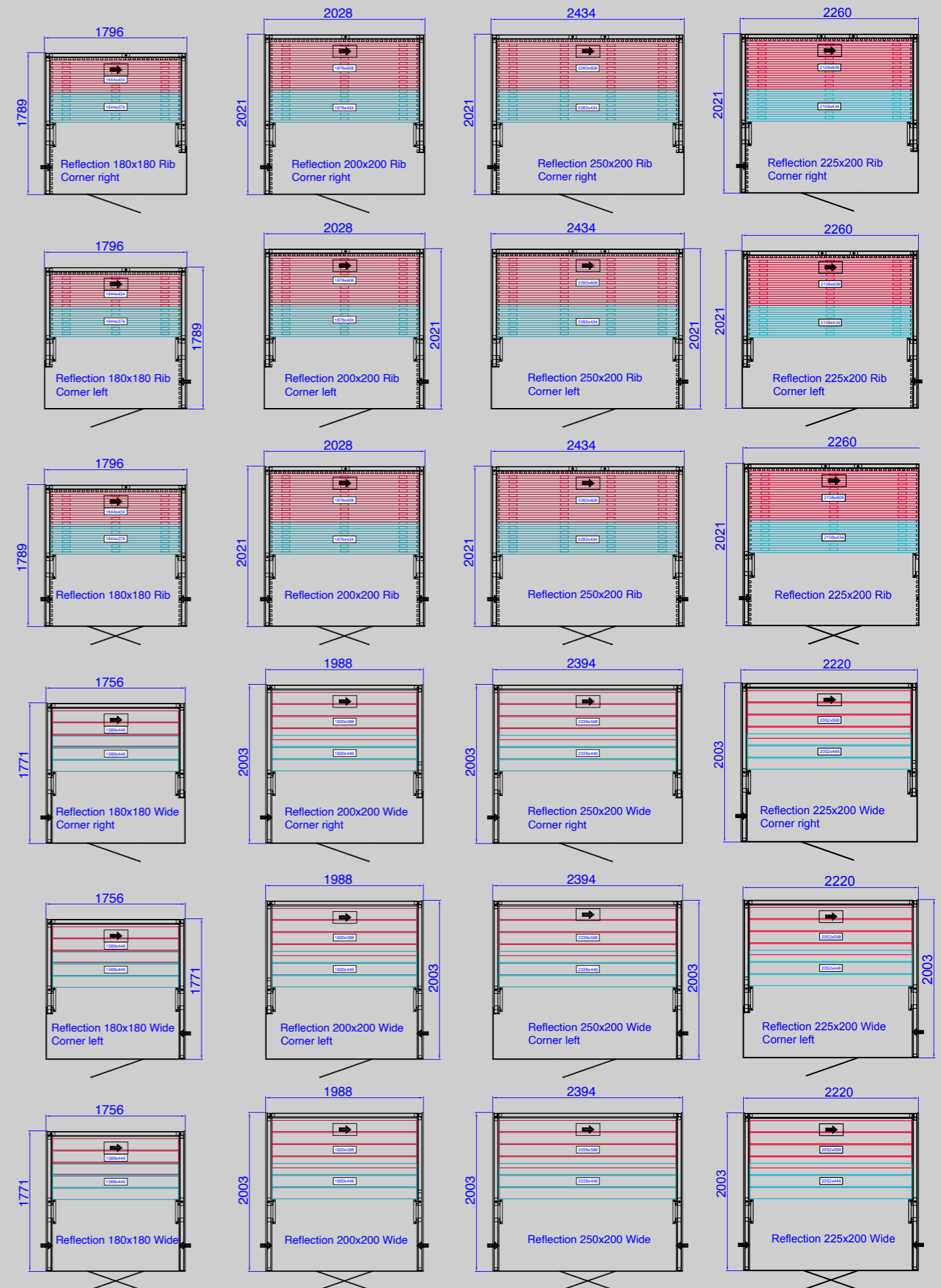

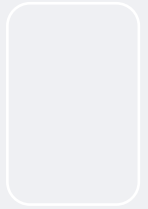

Over 75 years have passed since the Swedish founder of Tylö created his first sauna heater. We are proud of our heritage - solid traditions in craftsmanship, profound knowledge and Scandinavian legacy. Our passion is delivering top-quality sauna experiences - Soft Sauna and traditional saunas, steam baths, and soothing infrared warmth.

Enjoy your Tylö experience!

